

FEATURES

- SNR = 74.5 dBc (75.5 dBFS) in a 32.7 MHz BW at 70 MHz @ 150 MSPS
- SFDR = 80 dBc to 70 MHz @ 150 MSPS
- 1.8 V analog supply operation
- 1.8 V to 3.3 V CMOS output supply or 1.8 V LVDS output supply
- Integer 1-to-8 input clock divider
- Integrated dual-channel ADC
 - Sample rates up to 150 MSPS
 - IF sampling frequencies to 450 MHz
 - Internal ADC voltage reference
 - Integrated ADC sample-and-hold inputs
 - Flexible analog input range: 1 V p-p to 2 V p-p
 - ADC clock duty cycle stabilizer
 - 95 dB channel isolation/crosstalk
- Integrated wideband digital downconverter (DDC)
 - 32-bit complex, numerically controlled oscillator (NCO)
 - Decimating half-band filter and FIR filter
 - Supports real and complex output modes
- Fast attack/threshold detect bits
- Composite signal monitor
- Energy-saving power-down modes

APPLICATIONS

- Communications
 - Diversity radio systems
 - Multimode digital receivers (3G)
 - TD-SCDMA, WiMax, WCDMA, CDMA2000, GSM, EDGE, LTE
 - I/Q demodulation systems
 - Smart antenna systems
- General-purpose software radios
- Broadband data applications

PRODUCT HIGHLIGHTS

1. Integrated dual, 14-bit, 150 MSPS ADC.
2. Integrated wideband decimation filter and 32-bit complex NCO.
3. Fast overrange detect and signal monitor with serial output.
4. Proprietary differential input maintains excellent SNR performance for input frequencies up to 450 MHz.
5. Flexible output modes, including independent CMOS, interleaved CMOS, IQ mode CMOS, and interleaved LVDS.
6. SYNC input allows synchronization of multiple devices.
7. 3-bit SPI port for register programming and register readback.

FUNCTIONAL BLOCK DIAGRAM

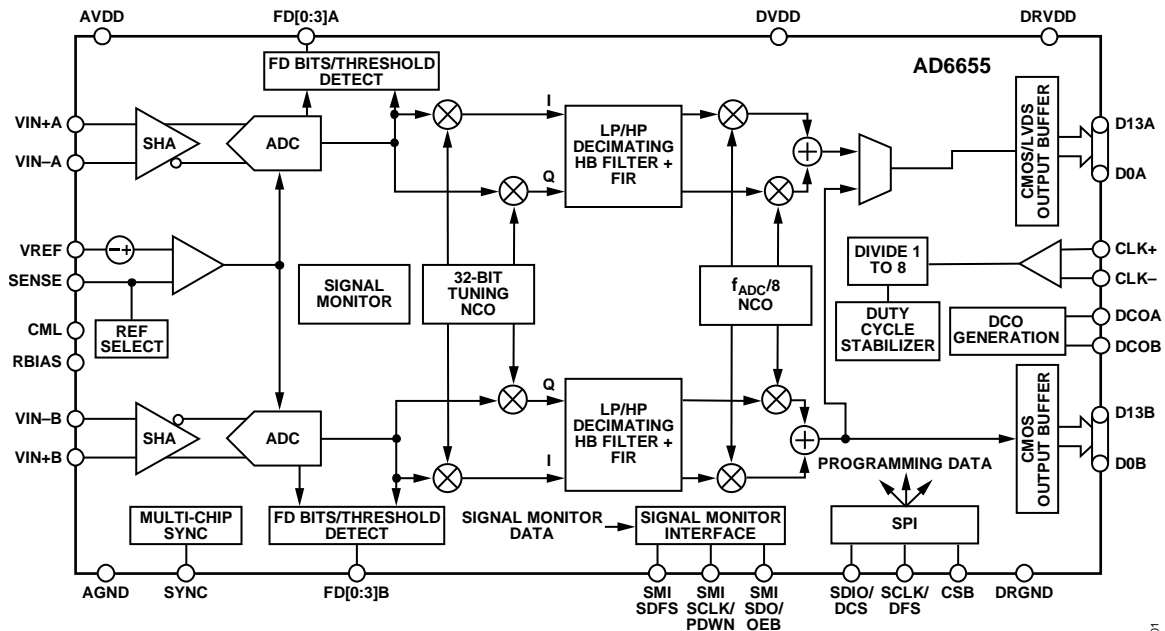

NOTES
1. PIN NAMES ARE FOR THE CMOS PIN CONFIGURATION ONLY; SEE FIGURE 10 FOR LVDS PIN NAMES.

Figure 1.

Rev. A

Information furnished by Analog Devices is believed to be accurate and reliable. However, no responsibility is assumed by Analog Devices for its use, nor for any infringements of patents or other rights of third parties that may result from its use. Specifications subject to change without notice. No license is granted by implication or otherwise under any patent or patent rights of Analog Devices. Trademarks and registered trademarks are the property of their respective owners.

TABLE OF CONTENTS

Features	1	Numerically Controlled Oscillator (NCO)	38
Applications	1	Frequency Translation	38
Product Highlights	1	NCO Synchronization	38
Functional Block Diagram	1	Phase Offset.....	38
Revision History	3	NCO Amplitude and Phase Dither	38
General Description	4	Decimating Half-Band Filter and FIR filter	39
Specifications.....	5	Half-Band Filter Coefficients.....	39
ADC DC Specifications—AD6655BCPZ-80/ AD6655BCPZ-105.....	5	Half-Band Filter Features	39
ADC DC Specifications—AD6655BCPZ-125/ AD6655BCPZ-150.....	6	Fixed-Coefficient FIR Filter.....	39
ADC AC Specifications—AD6655BCPZ-80/ AD6655BCPZ-105.....	7	Synchronization.....	40
ADC AC Specifications—AD6655BCPZ-125/ AD6655BCPZ-150.....	8	Combined Filter Performance.....	40
Digital Specifications—AD6655BCPZ-80/AD6655BCPZ-105..	9	Final NCO	40
Digital Specifications—AD6655BCPZ-125/ AD6655BCPZ-150.....	11	ADC Overrange and Gain Control.....	41
Switching Specifications—AD6655BCPZ-80/ AD6655BCPZ-105.....	13	Fast Detect Overview.....	41
Switching Specifications—AD6655BCPZ-125/ AD6655BCPZ-150.....	14	ADC Fast Magnitude.....	41
Timing Specifications	15	ADC Overrange (OR).....	42
Absolute Maximum Ratings.....	18	Gain Switching.....	42
Thermal Characteristics	18	Signal Monitor	44
ESD Caution.....	18	Peak Detector Mode.....	44
Pin Configurations and Function Descriptions	19	RMS/MS Magnitude Mode.....	44
Equivalent Circuits	23	Threshold Crossing Mode.....	45
Typical Performance Characteristics	24	Additional Control Bits	45
Theory of Operation	29	DC Correction.....	45
ADC Architecture	29	Signal Monitor SPORT Output	46
Analog Input Considerations.....	29	Channel/Chip Synchronization	47
Voltage Reference	31	Serial Port Interface (SPI).....	48
Clock Input Considerations.....	32	Configuration Using the SPI.....	48
Power Dissipation and Standby Mode.....	34	Hardware Interface.....	48
Digital Outputs	35	Configuration Without the SPI	49
Digital Downconverter	37	SPI Accessible Features.....	49
Downconverter Modes	37	Memory Map	50
Numerically Controlled Oscillator (NCO).....	37	Reading the Memory Map Register Table.....	50
Half-Band Decimating Filter and FIR Filter.....	37	Memory Map Register Table.....	51
$f_{\text{ADC}}/8$ Fixed-Frequency NCO	37	Memory Map Register Description	55
		Applications Information	59
		Design Guidelines	59
		Evaluation Board.....	61
		Power Supplies.....	61
		Input Signals.....	61

Output Signals61
Default Operation and Jumper Selection Settings.....62
Alternative Clock Configurations.....62
Alternative Analog Input Drive Configuration63
Schematics.....64

Evaluation Board Layouts74
Bill of Materials82
Outline Dimensions.....84
Ordering Guide85

REVISION HISTORY

9/09—Rev. 0 to Rev. A

Added Exposed Pad Notation to Figure 9 and Table 1219
Added Exposed Pad Notation to Figure 10 and Table 1321
Updated Outline Dimensions.....84
Changes to Ordering Guide.....85

11/07—Revision 0: Initial Version

GENERAL DESCRIPTION

The AD6655 is a mixed-signal intermediate frequency (IF) receiver consisting of dual 14-bit, 80 MSPS/105 MSPS/125 MSPS/150 MSPS ADCs and a wideband digital downconverter (DDC). The AD6655 is designed to support communications applications where low cost, small size, and versatility are desired.

The dual ADC core features a multistage, differential pipelined architecture with integrated output error correction logic. Each ADC features wide bandwidth differential sample-and-hold analog input amplifiers supporting a variety of user-selectable input ranges. An integrated voltage reference eases design considerations. A duty cycle stabilizer is provided to compensate for variations in the ADC clock duty cycle, allowing the converters to maintain excellent performance.

ADC data outputs are internally connected directly to the digital downconverter (DDC) of the receiver, simplifying layout and reducing interconnection parasitics. The digital receiver has two channels and provides processing flexibility. Each receive channel has four cascaded signal processing stages: a 32-bit frequency translator (numerically controlled oscillator (NCO)), a half-band decimating filter, a fixed FIR filter, and an $f_{ADC}/8$ fixed-frequency NCO.

In addition to the receiver DDC, the AD6655 has several functions that simplify the automatic gain control (AGC) function in the system receiver. The fast detect feature allows fast overrange detection by outputting four bits of input level information with short latency.

In addition, the programmable threshold detector allows monitoring of the incoming signal power using the four fast detect bits of the ADC with low latency. If the input signal level exceeds the programmable threshold, the coarse upper threshold indicator goes high. Because this threshold indicator has low latency, the user can quickly turn down the system gain to avoid an overrange condition.

The second AGC-related function is the signal monitor. This block allows the user to monitor the composite magnitude of the incoming signal, which aids in setting the gain to optimize the dynamic range of the overall system.

After digital processing, data can be routed directly to the two external 14-bit output ports. These outputs can be set from 1.8 V to 3.3 V CMOS or as 1.8 V LVDS. The CMOS data can also be output in an interleaved configuration at a double data rate using only Port A.

The AD6655 receiver digitizes a wide spectrum of IF frequencies. Each receiver is designed for simultaneous reception of the main channel and the diversity channel. This IF sampling architecture greatly reduces component cost and complexity compared with traditional analog techniques or less integrated digital methods.

Flexible power-down options allow significant power savings, when desired.

Programming for setup and control is accomplished using a 3-bit SPI-compatible serial interface.

The AD6655 is available in a 64-lead LFCSP and is specified over the industrial temperature range of -40°C to $+85^{\circ}\text{C}$.

SPECIFICATIONS

ADC DC SPECIFICATIONS—AD6655BCPZ-80/AD6655BCPZ-105

AVDD = 1.8 V, DVDD = 1.8 V, DRVDD = 1.8 V, maximum sample rate, VIN = -1.0 dBFS differential input, 1.0 V internal reference, DCS enabled, unless otherwise noted.

Table 1.

Parameter	Temperature	AD6655BCPZ-80			AD6655BCPZ-105			Unit
		Min	Typ	Max	Min	Typ	Max	
RESOLUTION	Full	14			14			Bits
ACCURACY		Guaranteed			Guaranteed			
No Missing Codes	Full							
Offset Error	Full		±0.2	±0.6		±0.2	±0.6	% FSR
Gain Error	Full	-3.6	-1.8	-0.1	-4.3	-2.2	-0.5	% FSR
MATCHING CHARACTERISTIC								
Offset Error	25°C		±0.2	±0.6		±0.2	±0.6	% FSR
Gain Error	25°C		±0.2	±0.75		±0.2	±0.75	% FSR
TEMPERATURE DRIFT								
Offset Error	Full		±15			±15		ppm/°C
Gain Error	Full		±95			±95		ppm/°C
INTERNAL VOLTAGE REFERENCE								
Output Voltage Error (1 V Mode)	Full		±5	±18		±5	±18	mV
Load Regulation @ 1.0 mA	Full		7			7		mV
INPUT-REFERRED NOISE								
VREF = 1.0 V	25°C		0.85			0.85		LSB rms
ANALOG INPUT								
Input Span, VREF = 1.0 V	Full		2			2		V p-p
Input Capacitance ¹	Full		8			8		pF
VREF INPUT RESISTANCE	Full		6			6		kΩ
POWER SUPPLIES								
Supply Voltage								
AVDD, DVDD	Full	1.7	1.8	1.9	1.7	1.8	1.9	V
DRVDD (CMOS Mode)	Full	1.7	3.3	3.6	1.7	3.3	3.6	V
DRVDD (LVDS Mode)	Full	1.7	1.8	1.9	1.7	1.8	1.9	V
Supply Current								
I _{AVDD} ^{2, 3}	Full		235	420		315	575	mA
I _{DVDD} ^{2, 3}	Full		175			225		mA
I _{DRVDD} ² (3.3 V CMOS)	Full		18			21		mA
I _{DRVDD} ² (1.8 V CMOS)	Full		8			11		mA
I _{DRVDD} ² (1.8 V LVDS)	Full		55			56		mA
POWER CONSUMPTION								
DC Input	Full		470	490		620	650	mW
Sine Wave Input ² (DRVDD = 1.8 V)	Full		755			995		mW
Sine Wave Input ² (DRVDD = 3.3 V)	Full		800			1040		mW
Standby Power ⁴	Full		52			68		mW
Power-Down Power	Full		2.5	8		2.5	8	mW

¹ Input capacitance refers to the effective capacitance between one differential input pin and AGND. See Figure 11 for the equivalent analog input structure.

² Measured with a 9.7 MHz, full-scale sine wave input, NCO enabled with a frequency of 13 MHz, FIR filter enabled and the f_s/8 output mix enabled with approximately 5 pF loading on each output bit.

³ The maximum limit applies to the combination of I_{AVDD} and I_{DVDD} currents.

⁴ Standby power is measured with a dc input and with the CLK pin inactive (set to AVDD or AGND).

AD6655

ADC DC SPECIFICATIONS—AD6655BCPZ-125/AD6655BCPZ-150

AVDD = 1.8 V, DVDD = 1.8 V, DRVDD = 1.8 V, maximum sample rate, VIN = –1.0 dBFS differential input, 1.0 V internal reference, DCS enabled, unless otherwise noted.

Table 2.

Parameter	Temperature	AD6655BCPZ-125			AD6655BCPZ-150			Unit
		Min	Typ	Max	Min	Typ	Max	
RESOLUTION	Full	14			14			Bits
ACCURACY								
No Missing Codes	Full	Guaranteed			Guaranteed			
Offset Error	Full		±0.3	±0.6		±0.2	±0.6	% FSR
Gain Error	Full	–4.7	–2.7	–0.8	–5.1	–3.2	–1.0	% FSR
MATCHING CHARACTERISTIC								
Offset Error	25°C		±0.3	±0.7		±0.2	±0.7	% FSR
Gain Error	25°C		±0.1	±0.7		±0.2	±0.8	% FSR
TEMPERATURE DRIFT								
Offset Error	Full		±15			±15		ppm/°C
Gain Error	Full		±95			±95		ppm/°C
INTERNAL VOLTAGE REFERENCE								
Output Voltage Error (1 V Mode)	Full		±5	±18		±5	±18	mV
Load Regulation @ 1.0 mA	Full		7			7		mV
INPUT-REFERRED NOISE								
VREF = 1.0 V	25°C		0.85			0.85		LSB rms
ANALOG INPUT								
Input Span, VREF = 1.0 V	Full		2			2		V p-p
Input Capacitance ¹	Full		8			8		pF
VREF INPUT RESISTANCE	Full		6			6		kΩ
POWER SUPPLIES								
Supply Voltage								
AVDD, DVDD	Full	1.7	1.8	1.9	1.7	1.8	1.9	V
DRVDD (CMOS Mode)	Full	1.7	1.8	3.6	1.7	1.8	3.6	V
DRVDD (LVDS Mode)	Full	1.7	1.8	1.9	1.7	1.8	1.9	V
Supply Current								
I _{AVDD} ^{2, 3}	Full		390	705		440	805	mA
I _{DVDD} ^{2, 3}	Full		270			320		mA
I _{DRVDD} ² (3.3 V CMOS)	Full		26			28		mA
I _{DRVDD} ² (1.8 V CMOS)	Full		13			17		mA
I _{DRVDD} ² (1.8 V LVDS)	Full		57			57		mA
POWER CONSUMPTION								
DC Input	Full		770	810		870	920	mW
Sine Wave Input ² (DRVDD = 1.8 V)	Full		1215			1395		mW
Sine Wave Input ² (DRVDD = 3.3 V)	Full		1275			1450		mW
Standby Power ⁴	Full		77			77		mW
Power-down Power	Full		2.5	8		2.5	8	mW

¹ Input capacitance refers to the effective capacitance between one differential input pin and AGND. See Figure 11 for the equivalent analog input structure.

² Measured with a 9.7 MHz, full-scale sine wave input, NCO enabled with a frequency of 13 MHz, FIR filter enabled and the f_s/8 output mix enabled with approximately 5 pF loading on each output bit.

³ The maximum limit applies to the combination of I_{AVDD} and I_{DVDD} currents.

⁴ Standby power is measured with a dc input, the CLK pin inactive (set to AVDD or AGND).

ADC AC SPECIFICATIONS—AD6655BCPZ-80/AD6655BCPZ-105

AVDD = 1.8 V, DVDD = 1.8 V, DRVDD = 1.8 V, maximum sample rate, VIN = -1.0 dBFS differential input, 1.0 V internal reference, DCS enabled, NCO enabled, half-band filter enabled, FIR filter enabled, unless otherwise noted.

Table 3.

Parameter ¹	Temperature	AD6655BCPZ-80			AD6655BCPZ-105			Unit
		Min	Typ	Max	Min	Typ	Max	
SIGNAL-TO-NOISE-RATIO (SNR)								
$f_{IN} = 2.4$ MHz	25°C		74.9			74.8		dB
$f_{IN} = 70$ MHz	25°C		74.8			74.7		dB
	Full	73.0			73.0			dB
$f_{IN} = 140$ MHz	25°C		74.5			74.3		dB
$f_{IN} = 220$ MHz	25°C		73.4			73.4		dB
WORST SECOND OR THIRD HARMONIC								
$f_{IN} = 2.4$ MHz	25°C		-86			-86		dBc
$f_{IN} = 70$ MHz	25°C		-85			-85		dBc
	Full			-74			-74	dBc
$f_{IN} = 140$ MHz	25°C		-84			-84		dBc
$f_{IN} = 220$ MHz	25°C		-83			-83		dBc
SPURIOUS-FREE DYNAMIC RANGE (SFDR)								
$f_{IN} = 2.4$ MHz	25°C		86			86		dBc
$f_{IN} = 70$ MHz	25°C		85			85		dBc
	Full	74			74			dBc
$f_{IN} = 140$ MHz	25°C		84			84		dBc
$f_{IN} = 220$ MHz	25°C		83			83		dBc
WORST OTHER HARMONIC OR SPUR ²								
$f_{IN} = 2.4$ MHz	25°C		-93			-93		dBc
$f_{IN} = 70$ MHz	25°C		-90			-90		dBc
	Full			-82			-82	dBc
$f_{IN} = 140$ MHz	25°C		-89			-89		dBc
$f_{IN} = 220$ MHz	25°C		-86			-86		dBc
TWO-TONE SFDR								
$f_{IN} = 29.12$ MHz, 32.12 MHz (-7 dBFS)	25°C		85			85		dBc
$f_{IN} = 169.12$ MHz, 172.12 MHz (-7 dBFS)	25°C		81			81		dBc
CROSSTALK ³	Full		95			95		dB
ANALOG INPUT BANDWIDTH	25°C		650			650		MHz

¹ See Application Note AN-835, *Understanding High Speed ADC Testing and Evaluation*, for a complete set of definitions.

² See the Applications Information section for more information about the worst other specifications for the AD6655.

³ Crosstalk is measured at 100 MHz with -1 dBFS on one channel and with no input on the alternate channel.

AD6655

ADC AC SPECIFICATIONS—AD6655BCPZ-125/AD6655BCPZ-150

AVDD = 1.8 V, DVDD = 1.8 V, DRVDD = 1.8 V, maximum sample rate, VIN = -1.0 dBFS differential input, 1.0 V internal reference, DCS enabled, NCO enabled, half-band filter enabled, FIR filter enabled, unless otherwise noted.

Table 4.

Parameter ¹	Temperature	AD6655BCPZ-125			AD6655BCPZ-150			Unit
		Min	Typ	Max	Min	Typ	Max	
SIGNAL-TO-NOISE-RATIO (SNR)	f _{IN} = 2.4 MHz		74.7			74.6		dB
	f _{IN} = 70 MHz		74.6			74.5		dB
		Full	73.0		72.5			dB
	f _{IN} = 140 MHz	25°C		74.2		73.9		dB
	f _{IN} = 220 MHz	25°C		73.3		73.0		dB
WORST SECOND OR THIRD HARMONIC	f _{IN} = 2.4 MHz	25°C		-86		-85		dBc
	f _{IN} = 70 MHz	25°C		-85		-84		dBc
		Full			-73		-73	dBc
	f _{IN} = 140 MHz	25°C		-84		-83		dBc
	f _{IN} = 220 MHz	25°C		-83		-77		dBc
SPURIOUS-FREE DYNAMIC RANGE (SFDR)	f _{IN} = 2.4 MHz	25°C		86		85		dBc
	f _{IN} = 70 MHz	25°C		85		80		dBc
		Full	73		73			dBc
	f _{IN} = 140 MHz	25°C		84		76		dBc
	f _{IN} = 220 MHz	25°C		83		74		dBc
WORST OTHER HARMONIC OR SPUR ²	f _{IN} = 2.4 MHz	25°C		-92		-87		dBc
	f _{IN} = 70 MHz	25°C		-90		-80		dBc
		Full			-82		-80	dBc
	f _{IN} = 140 MHz	25°C		-88		-76		dBc
	f _{IN} = 220 MHz	25°C		-84		-74		dBc
TWO-TONE SFDR	f _{IN} = 29.12 MHz, 32.12 MHz (-7 dBFS)	25°C		85		85		dBc
	f _{IN} = 169.12 MHz, 172.12 MHz (-7 dBFS)	25°C		81		81		dBc
CROSSTALK ³	Full		95		95		dB	
ANALOG INPUT BANDWIDTH	25°C		650		650		MHz	

¹ See Application Note AN-835, *Understanding High Speed ADC Testing and Evaluation*, for a complete set of definitions.

² See the Applications Information section for more information about the worst other specifications for the AD6655.

³ Crosstalk is measured at 100 MHz with -1 dBFS on one channel and with no input on the alternate channel.

DIGITAL SPECIFICATIONS—AD6655BCPZ-80/AD6655BCPZ-105

AVDD = 1.8 V, DVDD = 1.8 V, DRVDD = 1.8 V, maximum sample rate, VIN = -1.0 dBFS differential input, 1.0 V internal reference, DCS enabled, unless otherwise noted.

Table 5.

Parameter	Temp	AD6655BCPZ-80			AD6655BCPZ-105			Unit
		Min	Typ	Max	Min	Typ	Max	
DIFFERENTIAL CLOCK INPUTS (CLK+, CLK-)								
Logic Compliance		CMOS/LVDS/LVPECL			CMOS/LVDS/LVPECL			
Internal Common-Mode Bias	Full	1.2			1.2			V
Differential Input Voltage	Full	0.2		6	0.2		6	V p-p
Input Voltage Range	Full	AVDD - 0.3		AVDD + 1.6	AVDD - 0.3		AVDD + 1.6	V
Input Common-Mode Range	Full	1.1		AVDD	1.1		AVDD	V
High Level Input Voltage	Full	1.2		3.6	1.2		3.6	V
Low Level Input Voltage	Full	0		0.8	0		0.8	V
High Level Input Current	Full	-10		+10	-10		+10	μA
Low Level Input Current	Full	-10		+10	-10		+10	μA
Input Capacitance	Full	4			4			pF
Input Resistance	Full	8	10	12	8	10	12	kΩ
SYNC INPUT								
Logic Compliance		CMOS			CMOS			
Internal Bias	Full	1.2			1.2			V
Input Voltage Range	Full	AVDD - 0.3		AVDD + 1.6	AVDD - 0.3		AVDD + 1.6	V
High Level Input Voltage	Full	1.2		3.6	1.2		3.6	V
Low Level Input Voltage	Full	0		0.8	0		0.8	V
High Level Input Current	Full	-10		+10	-10		+10	μA
Low Level Input Current	Full	-10		+10	-10		+10	μA
Input Capacitance	Full	4			4			pF
Input Resistance	Full	8	10	12	8	10	12	kΩ
LOGIC INPUT (CSB)¹								
High Level Input Voltage	Full	1.22		3.6	1.22		3.6	V
Low Level Input Voltage	Full	0		0.6	0		0.6	V
High Level Input Current	Full	-10		+10	-10		+10	μA
Low Level Input Current	Full	40		132	40		132	μA
Input Resistance	Full	26			26			kΩ
Input Capacitance	Full	2			2			pF
LOGIC INPUT (SCLK/DFS)²								
High Level Input Voltage	Full	1.22		3.6	1.22		3.6	V
Low Level Input Voltage	Full	0		0.6	0		0.6	V
High Level Input Current	Full	-92		-135	-92		-135	μA
Low Level Input Current	Full	-10		+10	-10		+10	μA
Input Resistance	Full	26			26			kΩ
Input Capacitance	Full	2			2			pF
LOGIC INPUTS (SDIO/DCS, SMI SDFS)¹								
High Level Input Voltage	Full	1.22		3.6	1.22		3.6	V
Low Level Input Voltage	Full	0		0.6	0		0.6	V
High Level Input Current	Full	-10		+10	-10		+10	μA
Low Level Input Current	Full	38		128	38		128	μA
Input Resistance	Full	26			26			kΩ
Input Capacitance	Full	5			5			pF

AD6655

Parameter	Temp	AD6655BCPZ-80			AD6655BCPZ-105			Unit
		Min	Typ	Max	Min	Typ	Max	
LOGIC INPUTS (SMI SDO/OEB, SMI SCLK/PDWN) ²								
High Level Input Voltage	Full	1.22		3.6	1.22		3.6	V
Low Level Input Voltage	Full	0		0.6	0		0.6	V
High Level Input Current	Full	-90		-134	-90		-134	μA
Low Level Input Current	Full	-10		+10	-10		+10	μA
Input Resistance	Full		26			26		kΩ
Input Capacitance	Full		5			5		pF
DIGITAL OUTPUTS								
CMOS Mode—DRVDD = 3.3 V								
High Level Output Voltage								
I _{OH} = 50 μA	Full	3.29			3.29			V
I _{OH} = 0.5 mA	Full	3.25			3.25			V
Low Level Output Voltage								
I _{OL} = 1.6 mA	Full			0.2			0.2	V
I _{OL} = 50 μA	Full			0.05			0.05	V
CMOS Mode—DRVDD = 1.8 V								
High Level Output Voltage								
I _{OH} = 50 μA	Full	1.79			1.79			V
I _{OH} = 0.5 mA	Full	1.75			1.75			V
Low Level Output Voltage								
I _{OL} = 1.6 mA	Full			0.2			0.2	V
I _{OL} = 50 μA	Full			0.05			0.05	V
LVDS Mode, DRVDD = 1.8 V								
Differential Output Voltage (VOD), ANSI Mode	Full	250	350	450	250	350	450	mV
Output Offset Voltage (VOS), ANSI Mode	Full	1.15	1.25	1.35	1.15	1.25	1.35	V
Differential Output Voltage (VOD), Reduced Swing Mode	Full	150	200	280	150	200	280	mV
Output Offset Voltage (VOS), Reduced Swing Mode	Full	1.15	1.25	1.35	1.15	1.25	1.35	V

¹ Pull up.

² Pull down.

DIGITAL SPECIFICATIONS—AD6655BCPZ-125/AD6655BCPZ-150

AVDD = 1.8 V, DVDD = 1.8 V, DRVDD = 1.8 V, maximum sample rate, VIN = -1.0 dBFS differential input, 1.0 V internal reference, DCS enabled, unless otherwise noted.

Table 6.

Parameter	Temp	AD6655BCPZ-125			AD6655BCPZ-150			Unit
		Min	Typ	Max	Min	Typ	Max	
DIFFERENTIAL CLOCK INPUTS (CLK+, CLK-)								
Logic Compliance		CMOS/LVDS/LVPECL			CMOS/LVDS/LVPECL			
Internal Common-Mode Bias	Full	1.2			1.2			V
Differential Input Voltage	Full	0.2		6	0.2		6	V p-p
Input Voltage Range	Full	AVDD - 0.3		AVDD + 1.6	AVDD - 0.3		AVDD + 1.6	V
Input Common-Mode Range	Full	1.1 V		AVDD	1.1 V		AVDD	V
High Level Input Voltage	Full	1.2		3.6	1.2		3.6	V
Low Level Input Voltage	Full	0		0.8	0		0.8	V
High Level Input Current	Full	-10		+10	-10		+10	μA
Low Level Input Current	Full	-10		+10	-10		+10	μA
Input Capacitance	Full		4			4		pF
Input Resistance	Full	8	10	12	8	10	12	kΩ
SYNC INPUT								
Logic Compliance		CMOS			CMOS			
Internal Bias	Full	1.2			1.2			V
Input Voltage Range	Full	AVDD - 0.3		AVDD + 1.6	AVDD - 0.3		AVDD + 1.6	V
High Level Input Voltage	Full	1.2		3.6	1.2		3.6	V
Low Level Input Voltage	Full	0		0.8	0		0.8	V
High Level Input Current	Full	-10		+10	-10		+10	μA
Low Level Input Current	Full	-10		+10	-10		+10	μA
Input Capacitance	Full		4			4		pF
Input Resistance	Full	8	10	12	8	10	12	kΩ
LOGIC INPUT (CSB) ¹								
High Level Input Voltage	Full	1.22		3.6	1.22		3.6	V
Low Level Input Voltage	Full	0		0.6	0		0.6	V
High Level Input Current	Full	-10		+10	-10		+10	μA
Low Level Input Current	Full	40		132	40		132	μA
Input Resistance	Full		26			26		kΩ
Input Capacitance	Full		2			2		pF
LOGIC INPUT (SCLK/DFS) ²								
High Level Input Voltage	Full	1.22		3.6	1.22		3.6	V
Low Level Input Voltage	Full	0		0.6	0		0.6	V
High Level Input Current	Full	-92		-135	-92		-135	μA
Low Level Input Current	Full	-10		+10	-10		+10	μA
Input Resistance	Full		26			26		kΩ
Input Capacitance	Full		2			2		pF
LOGIC INPUTS (SDIO/DCS, SMI SDFS) ¹								
High Level Input Voltage	Full	1.22		3.6	1.22		3.6	V
Low Level Input Voltage	Full	0		0.6	0		0.6	V
High Level Input Current	Full	-10		+10	-10		+10	μA
Low Level Input Current	Full	38		128	38		128	μA
Input Resistance	Full		26			26		kΩ
Input Capacitance	Full		5			5		pF

AD6655

Parameter	Temp	AD6655BCPZ-125			AD6655BCPZ-150			Unit
		Min	Typ	Max	Min	Typ	Max	
LOGIC INPUTS (SMI SDO/OEB, SMI SCLK/PDWN) ²								
High Level Input Voltage	Full	1.22		3.6	1.22		3.6	V
Low Level Input Voltage	Full	0		0.6	0		0.6	V
High Level Input Current	Full	-90		-134	-90		-134	μA
Low Level Input Current	Full	-10		+10	-10		+10	μA
Input Resistance	Full		26			26		kΩ
Input Capacitance	Full		5			5		pF
DIGITAL OUTPUTS								
CMOS Mode—DRVDD = 3.3 V								
High Level Output Voltage								
$I_{OH} = 50 \mu\text{A}$	Full	3.29			3.29			V
$I_{OH} = 0.5 \text{ mA}$	Full	3.25			3.25			V
Low Level Output Voltage								
$I_{OL} = 1.6 \text{ mA}$	Full			0.2			0.2	V
$I_{OL} = 50 \mu\text{A}$	Full			0.05			0.05	V
CMOS Mode—DRVDD = 1.8 V								
High Level Output Voltage								
$I_{OH} = 50 \mu\text{A}$	Full	1.79			1.79			V
$I_{OH} = 0.5 \text{ mA}$	Full	1.75			1.75			V
Low Level Output Voltage								
$I_{OL} = 1.6 \text{ mA}$	Full			0.2			0.2	V
$I_{OL} = 50 \mu\text{A}$	Full			0.05			0.05	V
LVDS Mode—DRVDD = 1.8 V								
Differential Output Voltage (VOD), ANSI Mode	Full	250	350	450	250	350	450	mV
Output Offset Voltage (VOS), ANSI Mode	Full	1.15	1.25	1.35	1.15	1.25	1.35	V
Differential Output Voltage (VOD), Reduced Swing Mode	Full	150	200	280	150	200	280	mV
Output Offset Voltage (VOS), Reduced Swing Mode	Full	1.15	1.25	1.35	1.15	1.25	1.35	V

¹ Pull up.

² Pull down.

SWITCHING SPECIFICATIONS—AD6655BCPZ-80/AD6655BCPZ-105

Table 7.

Parameter	Temp	AD6655BCPZ-80			AD6655BCPZ-105			Unit
		Min	Typ	Max	Min	Typ	Max	
CLOCK INPUT PARAMETERS								
Input Clock Rate	Full			625			625	MHz
Conversion Rate ¹								
DCS Enabled	Full	20		80	20		105	MSPS
DCS Disabled	Full	10		80	10		105	MSPS
CLK Period—Divide-by-1 Mode (t_{CLK})	Full	12.5			9.5			ns
CLK Pulse Width High (t_{CLKH})								
Divide-by-1 Mode, DCS Enabled	Full	3.75	6.25	8.75	2.85	4.75	6.65	ns
Divide-by-1 Mode DCS Disabled	Full	5.63	6.25	6.88	4.28	4.75	5.23	ns
Divide-by-2 Mode, DCS Enabled	Full	1.6			1.6			ns
Divide-by-3 Through Divide-by-8 Modes, DCS Enabled	Full	0.8			0.8			ns
DATA OUTPUT PARAMETERS (DATA, FD)								
CMOS Noninterleaved Mode—DRVDD = 1.8 V								
Data Propagation Delay (t_{PD}) ²	Full	1.6	3.9	6.2	1.6	3.9	6.2	ns
DCO Propagation Delay (t_{DCO})	Full	4.0	5.4	7.3	4.0	5.4	7.3	ns
Setup Time (t_s)	Full		14.0			11.0		ns
Hold Time (t_H)	Full		11.0			8.0		ns
CMOS Noninterleaved Mode—DRVDD = 3.3 V								
Data Propagation Delay (t_{PD}) ²	Full	1.9	4.1	6.4	1.9	4.1	6.4	ns
DCO Propagation Delay (t_{DCO})	Full	4.4	5.8	7.7	4.4	5.8	7.7	ns
Setup Time (t_s)	Full		14.2			11.2		ns
Hold Time (t_H)	Full		10.8			7.8		ns
CMOS Interleaved and IQ Mode—DRVDD = 1.8 V								
Data Propagation Delay (t_{PD}) ²	Full	1.6	3.9	6.2	1.6	3.9	6.2	ns
DCO Propagation Delay (t_{DCO})	Full	3.4	4.8	6.7	3.4	4.8	6.7	ns
Setup Time (t_s)	Full		7.15			5.65		ns
Hold Time (t_H)	Full		5.35			3.85		ns
CMOS Interleaved and IQ Mode—DRVDD = 3.3 V								
Data Propagation Delay (t_{PD}) ²	Full	1.9	4.1	6.4	1.9	4.1	6.4	ns
DCO Propagation Delay (t_{DCO})	Full	3.8	5.2	7.1	3.8	5.2	7.1	ns
Setup Time (t_s)	Full		7.35			5.85		ns
Hold Time (t_H)	Full		5.15			3.65		ns
LVDS Mode—DRVDD = 1.8 V								
Data Propagation Delay (t_{PD}) ²	Full	2.5	4.8	7.0	2.5	4.8	7.0	ns
DCO Propagation Delay (t_{DCO})	Full	3.7	5.3	7.3	3.7	5.3	7.3	ns
Pipeline Delay (Latency) NCO, FIR, $f_s/8$ Mix Disabled	Full		38			38		Cycles
Pipeline Delay (Latency) NCO Enabled, FIR and $f_s/8$ Mix Disabled (Complex Output Mode)	Full		38			38		Cycles
Pipeline Delay (Latency) NCO, FIR, and $f_s/8$ Mix Enabled	Full		109			109		Cycles
Aperture Delay (t_A)	Full		1.0			1.0		ns
Aperture Uncertainty (Jitter, t_j)	Full		0.1			0.1		ps rms
Wake-Up Time ³	Full		350			350		us
OUT-OF-RANGE RECOVERY TIME	Full		2			2		Cycles

¹ Conversion rate is the clock rate after the divider.² Output propagation delay is measured from CLK 50% transition to DATA 50% transition, with a 5 pF load.³ Wake-up time is dependent on the value of the decoupling capacitors.

SWITCHING SPECIFICATIONS—AD6655BCPZ-125/AD6655BCPZ-150

Table 8.

Parameter	Temp	AD6655BCPZ-125			AD6655BCPZ-150			Unit
		Min	Typ	Max	Min	Typ	Max	
CLOCK INPUT PARAMETERS								
Input Clock Rate	Full			625			625	MHz
Conversion Rate ¹								
DCS Enabled	Full	20		125	20		150	MSPS
DCS Disabled	Full	10		125	10		150	MSPS
CLK Period—Divide-by-1 Mode (t_{CLK})	Full	8			6.66			ns
CLK Pulse Width High (t_{CLKH})								
Divide-by-1 Mode, DCS Enabled	Full	2.4	4	5.6	2.0	3.33	4.66	ns
Divide-by-1 Mode, DCS Disabled	Full	3.6	4	4.4	3.0	3.33	3.66	ns
Divide-by-2 Mode, DCS Enabled	Full	1.6			1.6			ns
Divide-by-3 Through Divide-by-8 Modes, DCS Enabled	Full	0.8			0.8			ns
DATA OUTPUT PARAMETERS (DATA, FD)								
CMOS Noninterleaved Mode—DRVDD = 1.8 V								
Data Propagation Delay (t_{PD}) ²	Full	1.6	3.9	6.2	1.6	3.9	6.2	ns
DCO Propagation Delay (t_{DCO})	Full	4.0	5.4	7.3	4.0	5.4	7.3	ns
Setup Time (t_s)	Full		9.5			8.16		ns
Hold Time (t_H)	Full		6.5			5.16		ns
CMOS Noninterleaved Mode—DRVDD = 3.3 V								
Data Propagation Delay (t_{PD}) ²	Full	1.9	4.1	6.4	1.9	4.1	6.4	ns
DCO Propagation Delay (t_{DCO})	Full	4.4	5.8	7.7	4.4	5.8	7.7	ns
Setup Time (t_s)	Full		9.7			8.36		ns
Hold Time (t_H)	Full		6.3			4.96		ns
CMOS Interleaved and IQ Mode—DRVDD = 1.8 V								
Data Propagation Delay (t_{PD}) ²	Full	1.6	3.9	6.2	1.6	3.9	6.2	ns
DCO Propagation Delay (t_{DCO})	Full	3.4	4.8	6.7	3.4	4.8	6.7	ns
Setup Time (t_s)	Full		4.9			4.23		ns
Hold Time (t_H)	Full		3.1			2.43		ns
CMOS Interleaved and IQ Mode—DRVDD = 3.3 V								
Data Propagation Delay (t_{PD}) ²	Full	1.9	4.1	6.4	1.9	4.1	6.4	ns
DCO Propagation Delay (t_{DCO})	Full	3.8	5.2	7.1	3.8	5.2	7.1	ns
Setup Time (t_s)	Full		5.1			4.43		ns
Hold Time (t_H)	Full		2.9			2.23		ns
LVDS Mode—DRVDD = 1.8 V								
Data Propagation Delay (t_{PD}) ²	Full	2.5	4.8	7.0	2.5	4.8	7.0	ns
DCO Propagation Delay (t_{DCO})	Full	3.7	5.3	7.3	3.7	5.3	7.3	ns
Pipeline Delay (Latency) NCO, FIR, $f_s/8$ Mix Disabled	Full		38			38		Cycles
Pipeline Delay (Latency) NCO Enabled; FIR and $f_s/8$ Mix Disabled (Complex Output Mode)	Full		38			38		Cycles
Pipeline Delay (Latency) NCO, FIR, and $f_s/8$ Mix Enabled	Full		109			109		Cycles
Aperture Delay (t_A)	Full		1.0			1.0		ns
Aperture Uncertainty (Jitter, t_j)	Full		0.1			0.1		ps rms
Wake-Up Time ³	Full		350			350		us
OUT-OF-RANGE RECOVERY TIME	Full		3			3		Cycles

¹ Conversion rate is the clock rate after the divider.

² Output propagation delay is measured from CLK 50% transition to DATA 50% transition, with a 5 pF load.

³ Wake-up time is dependent on the value of the decoupling capacitors.

TIMING SPECIFICATIONS

Table 9.

Parameter	Conditions	Min	Typ	Max	Unit
SYNC TIMING REQUIREMENTS					
t_{SSYNC}	SYNC to the rising edge of CLK setup time		0.24		ns
t_{HSYNC}	SYNC to the rising edge of CLK hold time		0.4		ns
SPI TIMING REQUIREMENTS					
t_{DS}	Setup time between the data and the rising edge of SCLK	2			ns
t_{DH}	Hold time between the data and the rising edge of SCLK	2			ns
t_{CLK}	Period of the SCLK	40			ns
t_S	Setup time between CSB and SCLK	2			ns
t_H	Hold time between CSB and SCLK	2			ns
t_{HIGH}	Minimum period that SCLK should be in a logic high state	10			ns
t_{LOW}	Minimum period that SCLK should be in a logic low state	10			ns
t_{EN_SDIO}	Time required for the SDIO pin to switch from an input to an output relative to the SCLK falling edge	10			ns
t_{DIS_SDIO}	Time required for the SDIO pin to switch from an output to an input relative to the SCLK rising edge	10			ns
SPORT TIMING REQUIREMENTS					
t_{CSSCLK}	Delay from rising edge of CLK+ to rising edge of SMI SCLK	3.2	4.5	6.2	ns
$t_{SSLKSDO}$	Delay from rising edge of SMI SCLK to SMI SDO	-0.4	0	+0.4	ns
$t_{SSCLKSDFS}$	Delay from rising edge of SMI SCLK to SMI SDFS	-0.4	0	+0.4	ns

Timing Diagrams

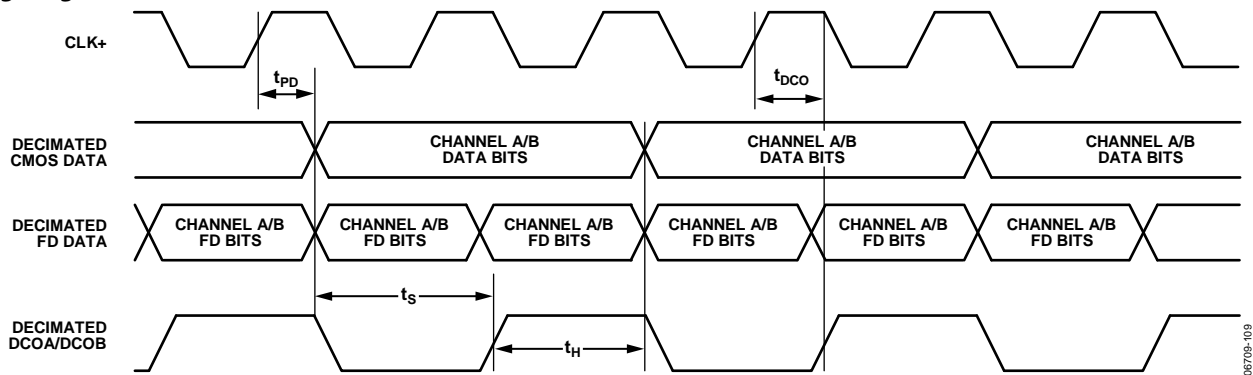

Figure 2. Decimated Noninterleaved CMOS Mode Data and Fast Detect Output Timing (Fast Detect Mode Select Bits = 000)

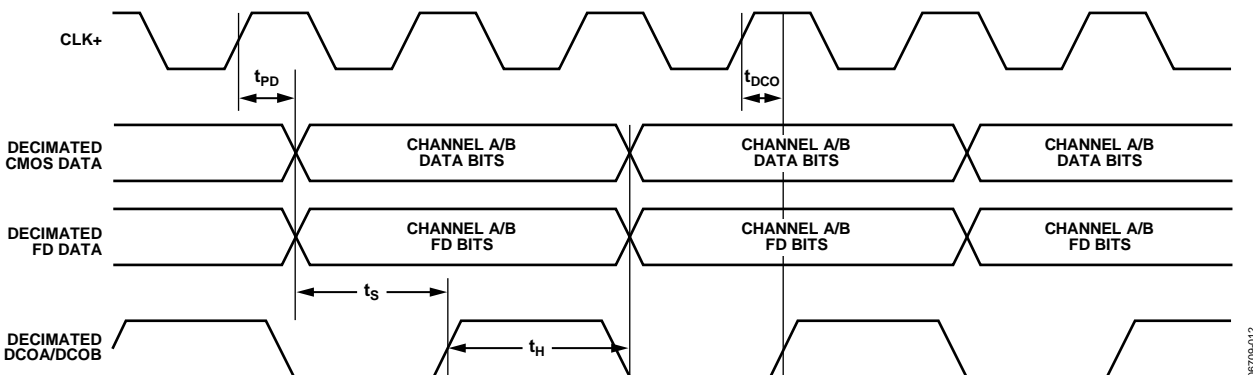
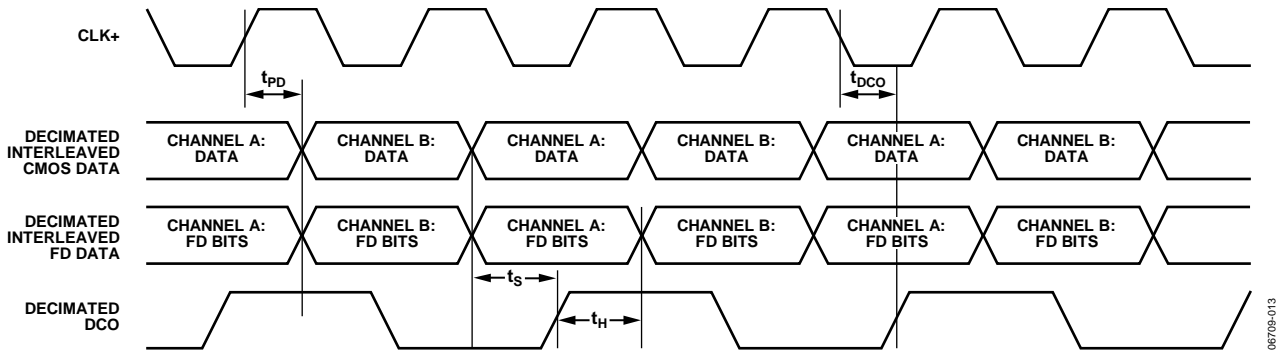
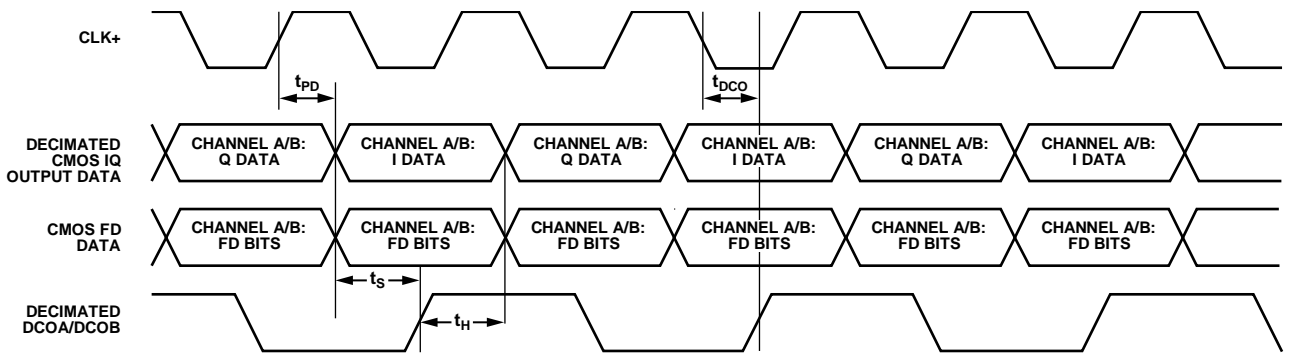

Figure 3. Decimated Noninterleaved CMOS Mode Data and Fast Detect Output Timing (Fast Detect Mode Select Bits = 001 Through Fast Detect Mode Select Bits = 100)



06709-013



06709-014

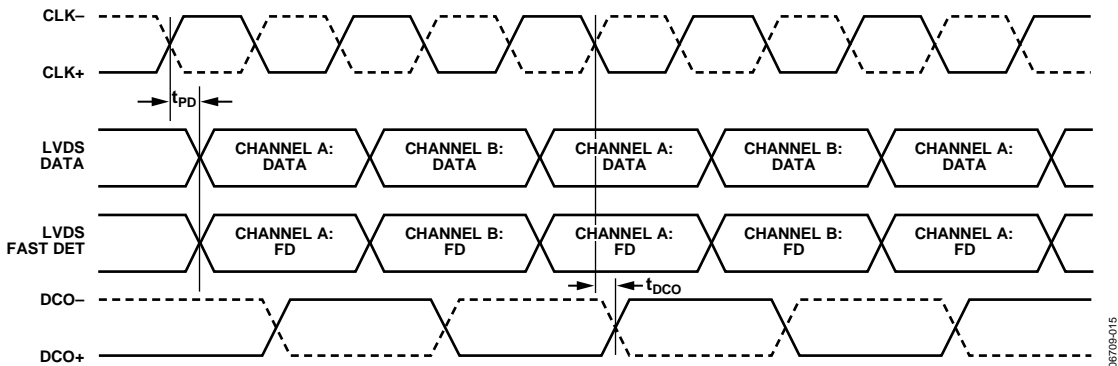

06709-015

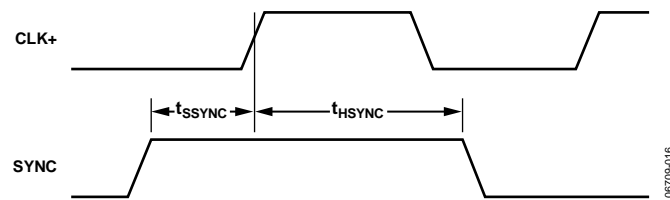

06709-016

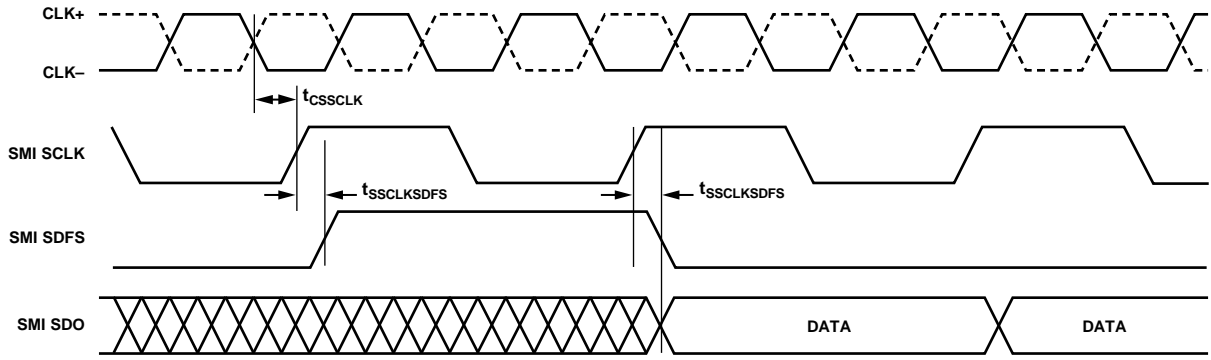

Figure 8. Signal Monitor SPORT Output Timing

087709-017

ABSOLUTE MAXIMUM RATINGS

Table 10.

Parameter	Rating
ELECTRICAL	
AVDD, DVDD to AGND	–0.3 V to +2.0 V
DRVDD to DRGND	–0.3 V to +3.9 V
AGND to DRGND	–0.3 V to +0.3 V
VIN+A/VIN+B, VIN-A/VIN-B to AGND	–0.3 V to AVDD + 0.2 V
CLK+, CLK– to AGND	–0.3 V to +3.9 V
SYNC to AGND	–0.3 V to +3.9 V
VREF to AGND	–0.3 V to AVDD + 0.2 V
SENSE to AGND	–0.3 V to AVDD + 0.2 V
CML to AGND	–0.3 V to AVDD + 0.2 V
RBIAS to AGND	–0.3 V to AVDD + 0.2 V
CSB to AGND	–0.3 V to +3.9 V
SCLK/DFS to DRGND	–0.3 V to +3.9 V
SDIO/DCS to DRGND	–0.3 V to DRVDD + 0.3 V
SMI SDO/OEB to DRGND	–0.3 V to DRVDD + 0.3 V
SMI SCLK/PDWN to DRGND	–0.3 V to DRVDD + 0.3 V
SMI SDFS to DRGND	–0.3 V to DRVDD + 0.3 V
D0A/D0B through D13A/D13B to DRGND	–0.3 V to DRVDD + 0.3 V
FD0A/FD0B through FD3A/FD3B to DRGND	–0.3 V to DRVDD + 0.3 V
DCOA/DCOB to DRGND	–0.3 V to DRVDD + 0.3 V
ENVIRONMENTAL	
Operating Temperature Range (Ambient)	–40°C to +85°C
Maximum Junction Temperature Under Bias	150°C
Storage Temperature Range (Ambient)	–65°C to +125°C

Stresses above those listed under Absolute Maximum Ratings may cause permanent damage to the device. This is a stress rating only; functional operation of the device at these or any other conditions above those indicated in the operational section of this specification is not implied. Exposure to absolute maximum rating conditions for extended periods may affect device reliability.

THERMAL CHARACTERISTICS

The exposed paddle must be soldered to the ground plane for the LFCSP package. Soldering the exposed paddle to the customer board increases the reliability of the solder joints, maximizing the thermal capability of the package.

Table 11. Thermal Resistance

Package Type	Airflow Velocity (m/s)	$\theta_{JA}^{1,2}$	$\theta_{JC}^{1,3}$	$\theta_{JB}^{1,4}$	Unit
64-Lead LFCSP 9 mm × 9 mm (CP-64-3)	0	18.8	0.6	6.0	°C/W
	1.0	16.5			°C/W
	2.0	15.8			°C/W

¹ Per JEDEC 51-7, plus JEDEC 25-5 2S2P test board.

² Per JEDEC JESD51-2 (still air) or JEDEC JESD51-6 (moving air).

³ Per MIL-Std 883, Method 1012.1.

⁴ Per JEDEC JESD51-8 (still air).

Typical θ_{JA} is specified for a 4-layer PCB with solid ground plane. As shown, airflow increases heat dissipation, which reduces θ_{JA} . In addition, metal in direct contact with the package leads from metal traces, through holes, ground, and power planes, reduces the θ_{JA} .

ESD CAUTION



ESD (electrostatic discharge) sensitive device. Charged devices and circuit boards can discharge without detection. Although this product features patented or proprietary protection circuitry, damage may occur on devices subjected to high energy ESD. Therefore, proper ESD precautions should be taken to avoid performance degradation or loss of functionality.

PIN CONFIGURATIONS AND FUNCTION DESCRIPTIONS

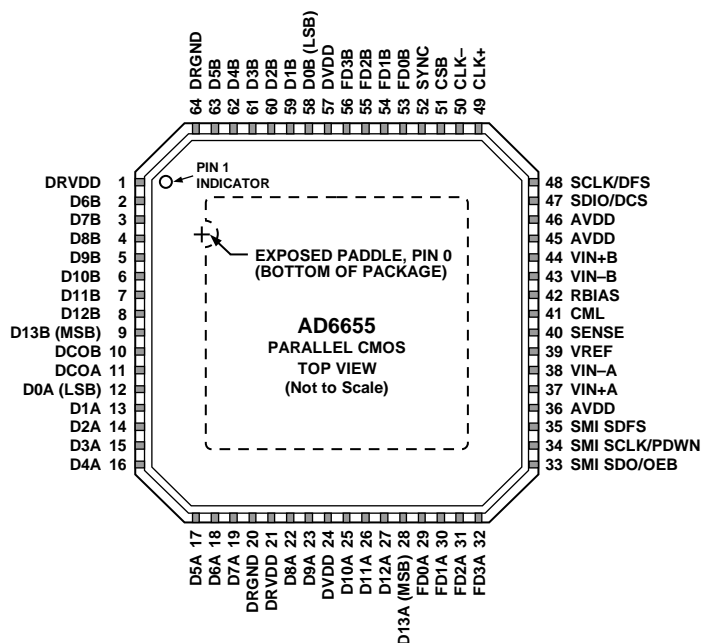

NOTES

1. THE EXPOSED THERMAL PAD ON THE BOTTOM OF THE PACKAGE PROVIDES THE ANALOG GROUND FOR THE PART. THIS EXPOSED PAD MUST BE CONNECTED TO GROUND FOR PROPER OPERATION.

06709-002

Figure 9. LFCSP Parallel CMOS Pin Configuration (Top View)

Table 12. Pin Function Descriptions (Parallel CMOS Mode)

Pin No.	Mnemonic	Type	Description
ADC Power Supplies			
20, 64	DRGND	Ground	Digital Output Ground.
1, 21	DRVDD	Supply	Digital Output Driver Supply (1.8 V to 3.3 V).
24, 57	DVDD	Supply	Digital Power Supply (1.8 V Nominal).
36, 45, 46	AVDD	Supply	Analog Power Supply (1.8 V Nominal).
0	AGND, Exposed Pad	Ground	Analog Ground. The exposed thermal pad on the bottom of the package provides the analog ground for the part. This pad must be connected to ground for proper operation.
ADC Analog			
37	VIN+A	Input	Differential Analog Input Pin (+) for Channel A.
38	VIN-A	Input	Differential Analog Input Pin (-) for Channel A.
44	VIN+B	Input	Differential Analog Input Pin (+) for Channel B.
43	VIN-B	Input	Differential Analog Input Pin (-) for Channel B.
39	VREF	Input/Output	Voltage Reference Input/Output.
40	SENSE	Input	Voltage Reference Mode Select. (See Table 15 for details.)
42	RBIAS	Input/Output	External Reference Bias Resistor.
41	CML	Output	Common-Mode Level Bias Output for Analog Inputs.
49	CLK+	Input	ADC Clock Input—True.
50	CLK-	Input	ADC Clock Input—Complement.
ADC Fast Detect Outputs			
29	FD0A	Output	Channel A Fast Detect Indicator. (See Table 21 for details.)
30	FD1A	Output	Channel A Fast Detect Indicator. (See Table 21 for details.)
31	FD2A	Output	Channel A Fast Detect Indicator. (See Table 21 for details.)
32	FD3A	Output	Channel A Fast Detect Indicator. (See Table 21 for details.)
53	FD0B	Output	Channel B Fast Detect Indicator. (See Table 21 for details.)
54	FD1B	Output	Channel B Fast Detect Indicator. (See Table 21 for details.)
55	FD2B	Output	Channel B Fast Detect Indicator. (See Table 21 for details.)
56	FD3B	Output	Channel B Fast Detect Indicator. (See Table 21 for details.)

AD6655

Pin No.	Mnemonic	Type	Description
Digital Input			
52	SYNC	Input	Digital Synchronization Pin. Slave mode only.
Digital Outputs			
12	D0A (LSB)	Output	Channel A CMOS Output Data.
13	D1A	Output	Channel A CMOS Output Data.
14	D2A	Output	Channel A CMOS Output Data.
15	D3A	Output	Channel A CMOS Output Data.
16	D4A	Output	Channel A CMOS Output Data.
17	D5A	Output	Channel A CMOS Output Data.
18	D6A	Output	Channel A CMOS Output Data.
19	D7A	Output	Channel A CMOS Output Data.
22	D8A	Output	Channel A CMOS Output Data.
23	D9A	Output	Channel A CMOS Output Data.
25	D10A	Output	Channel A CMOS Output Data.
26	D11A	Output	Channel A CMOS Output Data.
27	D12A	Output	Channel A CMOS Output Data.
28	D13A (MSB)	Output	Channel A CMOS Output Data.
58	D0B (LSB)	Output	Channel B CMOS Output Data.
59	D1B	Output	Channel B CMOS Output Data.
60	D2B	Output	Channel B CMOS Output Data.
61	D3B	Output	Channel B CMOS Output Data.
62	D4B	Output	Channel B CMOS Output Data.
63	D5B	Output	Channel B CMOS Output Data.
2	D6B	Output	Channel B CMOS Output Data.
3	D7B	Output	Channel B CMOS Output Data.
4	D8B	Output	Channel B CMOS Output Data.
5	D9B	Output	Channel B CMOS Output Data.
6	D10B	Output	Channel B CMOS Output Data.
7	D11B	Output	Channel B CMOS Output Data.
8	D12B	Output	Channel B CMOS Output Data.
9	D13B (MSB)	Output	Channel B CMOS Output Data.
11	DCOA	Output	Channel A Data Clock Output.
10	DCOB	Output	Channel B Data Clock Output.
SPI Control			
48	SCLK/DFS	Input	SPI Serial Clock/Data Format Select Pin in External Pin Mode.
47	SDIO/DCS	Input/Output	SPI Serial Data I/O/Duty Cycle Stabilizer Pin in External Pin Mode.
51	CSB	Input	SPI Chip Select. Active low.
Signal Monitor Port			
33	SMI SDO/OEB	Input/Output	Signal Monitor Serial Data Output/Output Enable Input (Active Low) in External Pin Mode.
35	SMI SDFS	Output	Signal Monitor Serial Data Frame Sync.
34	SMI SCLK/PDWN	Input/Output	Signal Monitor Serial Clock Output/Power-Down Input (Active High) in External Pin Mode.

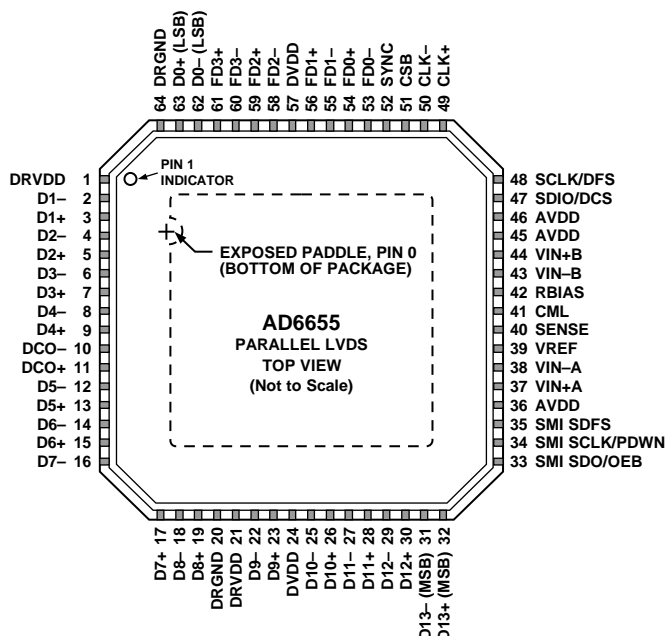

NOTES
 1. THE EXPOSED THERMAL PAD ON THE BOTTOM OF THE PACKAGE PROVIDES THE ANALOG GROUND FOR THE PART. THIS EXPOSED PAD MUST BE CONNECTED TO GROUND FOR PROPER OPERATION.

06709-003

Figure 10. LFCSP Interleaved Parallel LVDS Pin Configuration (Top View)

Table 13. Pin Function Descriptions (Interleaved Parallel LVDS Mode)

Pin No.	Mnemonic	Type	Description
ADC Power Supplies			
20, 64	DRGND	Ground	Digital Output Ground.
1, 21	DRVDD	Supply	Digital Output Driver Supply (1.8 V to 3.3 V).
24, 57	DVDD	Supply	Digital Power Supply (1.8 V Nominal.)
36, 45, 46	AVDD	Supply	Analog Power Supply (1.8 V Nominal.)
0	AGND, Exposed Pad	Ground	Analog Ground. The exposed thermal pad on the bottom of the package provides the analog ground for the part. This exposed pad must be connected to ground for proper operation.
ADC Analog			
37	VIN+A	Input	Differential Analog Input Pin (+) for Channel A.
38	VIN-A	Input	Differential Analog Input Pin (-) for Channel A.
44	VIN+B	Input	Differential Analog Input Pin (+) for Channel B.
43	VIN-B	Input	Differential Analog Input Pin (-) for Channel B.
39	VREF	Input/Output	Voltage Reference Input/Output.
40	SENSE	Input	Voltage Reference Mode Select. See Table 15 for details.
42	RBIAS	Input/Output	External Reference Bias Resistor.
41	CML	Output	Common-Mode Level Bias Output for Analog Inputs.
49	CLK+	Input	ADC Clock Input—True.
50	CLK-	Input	ADC Clock Input—Complement.
ADC Fast Detect Outputs			
54	FD0+	Output	Channel A/Channel B LVDS Fast Detect Indicator 0—True. See Table 21 for details.
53	FD0-	Output	Channel A/Channel B LVDS Fast Detect Indicator 0—Complement. See Table 21 for details.
56	FD1+	Output	Channel A/Channel B LVDS Fast Detect Indicator 1—True. See Table 21 for details.
55	FD1-	Output	Channel A/Channel B LVDS Fast Detect Indicator 1—Complement. See Table 21 for details.
59	FD2+	Output	Channel A/Channel B LVDS Fast Detect Indicator 2—True. See Table 21 for details.
58	FD2-	Output	Channel A/Channel B LVDS Fast Detect Indicator 2—Complement. See Table 21 for details.
61	FD3+	Output	Channel A/Channel B LVDS Fast Detect Indicator 3—True. See Table 21 for details.
60	FD3-	Output	Channel A/Channel B LVDS Fast Detect Indicator 3—Complement. See Table 21 for details.

AD6655

Pin No.	Mnemonic	Type	Description
Digital Input			
52	SYNC	Input	Digital Synchronization Pin. Slave mode only.
Digital Outputs			
63	D0+ (LSB)	Output	Channel A/Channel B LVDS Output Data 0—True.
62	D0– (LSB)	Output	Channel A/Channel B LVDS Output Data 0—Complement.
3	D1+	Output	Channel A/Channel B LVDS Output Data 1—True.
2	D1–	Output	Channel A/Channel B LVDS Output Data 1—Complement.
5	D2+	Output	Channel A/Channel B LVDS Output Data 2—True.
4	D2–	Output	Channel A/Channel B LVDS Output Data 2—Complement.
7	D3+	Output	Channel A/Channel B LVDS Output Data 3—True.
6	D3–	Output	Channel A/Channel B LVDS Output Data 3—Complement.
9	D4+	Output	Channel A/Channel B LVDS Output Data 4—True.
8	D4–	Output	Channel A/Channel B LVDS Output Data 4—Complement.
13	D5+	Output	Channel A/Channel B LVDS Output Data 5—True.
12	D5–	Output	Channel A/Channel B LVDS Output Data 5—Complement.
15	D6+	Output	Channel A/Channel B LVDS Output Data 6—True.
14	D6–	Output	Channel A/Channel B LVDS Output Data 6—Complement.
17	D7+	Output	Channel A/Channel B LVDS Output Data 7—True.
16	D7–	Output	Channel A/Channel B LVDS Output Data 7—Complement.
19	D8+	Output	Channel A/Channel B LVDS Output Data 8—True.
18	D8–	Output	Channel A/Channel B LVDS Output Data 8—Complement.
23	D9+	Output	Channel A/Channel B LVDS Output Data 9—True.
22	D9–	Output	Channel A/Channel B LVDS Output Data 9—Complement.
26	D10+	Output	Channel A/Channel B LVDS Output Data 10—True.
25	D10–	Output	Channel A/Channel B LVDS Output Data 10—Complement.
28	D11+	Output	Channel A/Channel B LVDS Output Data 11—True.
27	D11–	Output	Channel A/Channel B LVDS Output Data 11—Complement.
30	D12+	Output	Channel A/Channel B LVDS Output Data 12—True.
29	D12–	Output	Channel A/Channel B LVDS Output Data 12—Complement.
32	D13+ (MSB)	Output	Channel A/Channel B LVDS Output Data 13—True.
31	D13– (MSB)	Output	Channel A/Channel B LVDS Output Data 13—Complement.
11	DCO+	Output	Channel A/Channel B LVDS Data Clock Output—True.
10	DCO–	Output	Channel A/Channel B LVDS Data Clock Output—Complement.
SPI Control			
48	SCLK/DFS	Input	SPI Serial Clock/Data Format Select Pin in External Pin Mode.
47	SDIO/DCS	Input/Output	SPI Serial Data I/O/Duty Cycle Stabilizer in External Pin Mode.
51	CSB	Input	SPI Chip Select (Active Low).
Signal Monitor Port			
33	SMI SDO/OEB	Input/Output	Signal Monitor Serial Data Output/Output Enable Input (Active Low) in External Pin Mode.
35	SMI SDFS	Output	Signal Monitor Serial Data Frame Sync.
34	SMI SCLK/PDWN	Input/Output	Signal Monitor Serial Clock Output/Power-Down Input (Active High) in External Pin Mode.

EQUIVALENT CIRCUITS

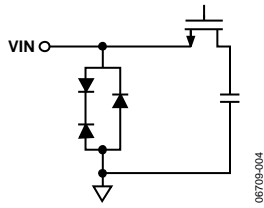

Figure 11. Equivalent Analog Input Circuit

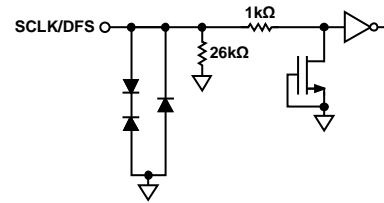

Figure 15. Equivalent SCLK/DFS Input Circuit

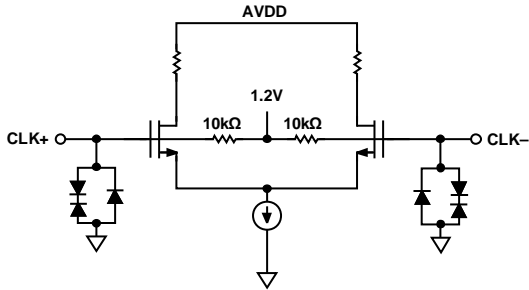

Figure 12. Equivalent Clock Input Circuit

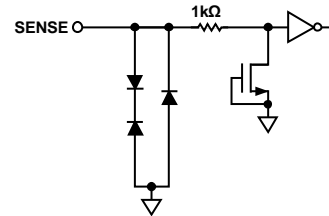

Figure 16. Equivalent SENSE Circuit

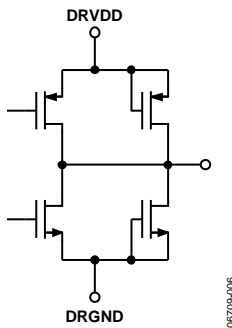

Figure 13. Equivalent Digital Output Circuit

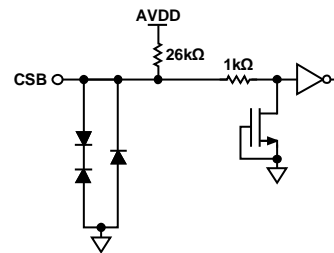

Figure 17. Equivalent CSB Input Circuit

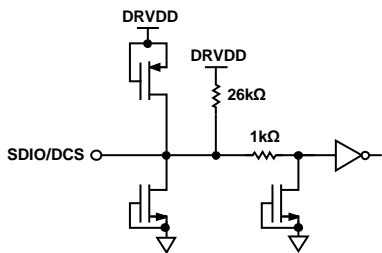

Figure 14. Equivalent SDIO/DCS Circuit or SMI SDFS Circuit

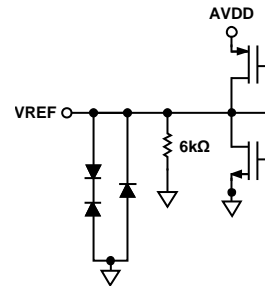

Figure 18. Equivalent VREF Circuit

TYPICAL PERFORMANCE CHARACTERISTICS

AVDD = 1.8 V, DVDD = 1.8 V, DRVDD = 1.8 V, sample rate = 150 MSPS, DCS enabled, 1.0 V internal reference, 2 V p-p differential input, VIN = -1.0 dBFS, 64k sample, TA = 25°C, NCO enabled, FIR filter enabled, unless otherwise noted. In the FFT plots that follow, the location of the second and third harmonics is noted when they fall in the pass band of the filter.

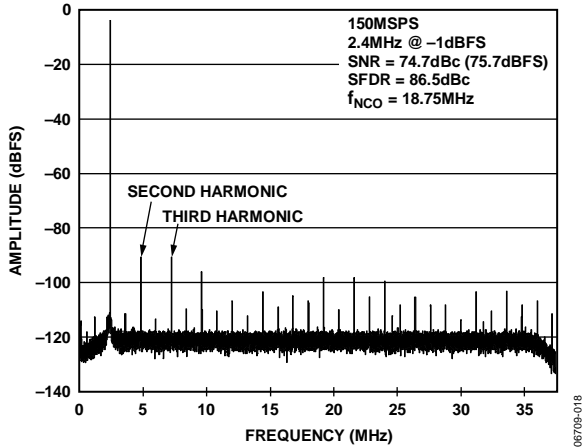

Figure 19. AD6655-150 Single-Tone FFT with $f_{IN} = 2.4$ MHz, $f_{NCO} = 18.75$ MHz

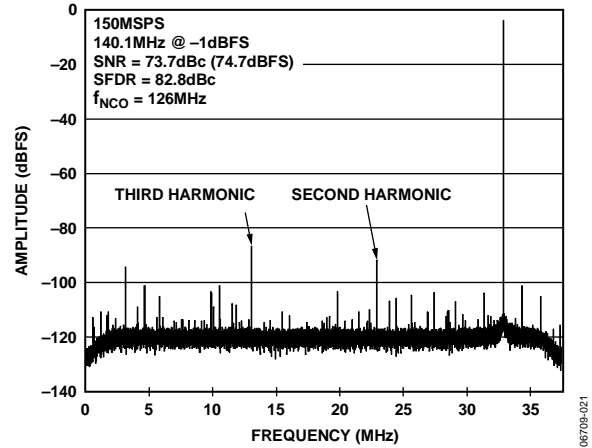

Figure 22. AD6655-150 Single-Tone FFT with $f_{IN} = 140.1$ MHz, $f_{NCO} = 126$ MHz

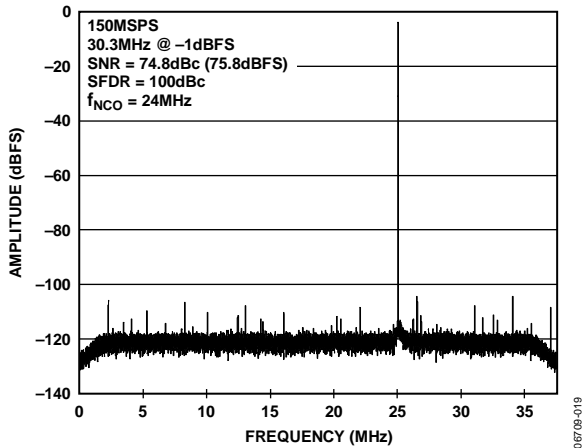

Figure 20. AD6655-150 Single-Tone FFT with $f_{IN} = 30.3$ MHz, $f_{NCO} = 24$ MHz

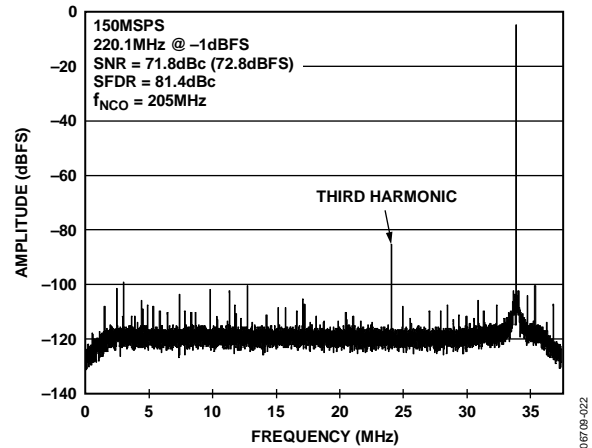

Figure 23. AD6655-150 Single-Tone FFT with $f_{IN} = 220.1$ MHz, $f_{NCO} = 205$ MHz

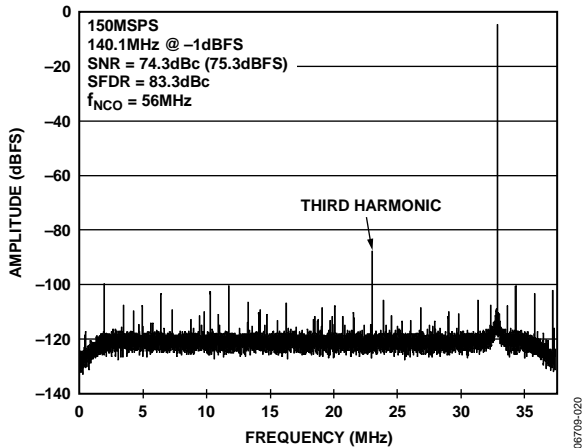

Figure 21. AD6655-150 Single-Tone FFT with $f_{IN} = 70.1$ MHz, $f_{NCO} = 56$ MHz

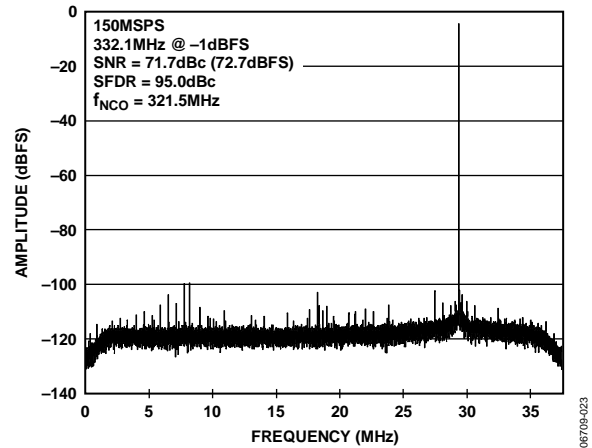

Figure 24. AD6655-150 Single-Tone FFT with $f_{IN} = 332.1$ MHz, $f_{NCO} = 321.5$ MHz

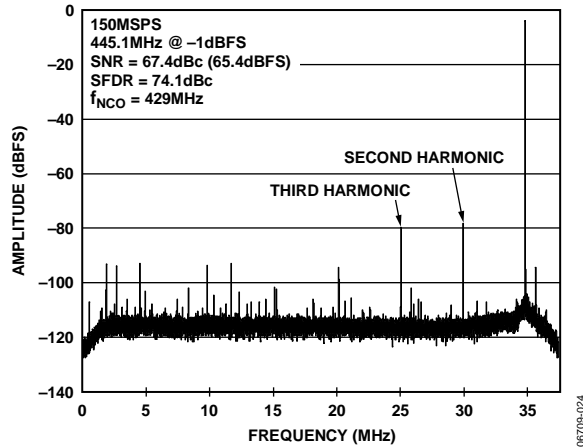

Figure 25. AD6655-150 Single-Tone FFT with $f_{IN} = 445.1\text{ MHz}$, $f_{NCO} = 429\text{ MHz}$

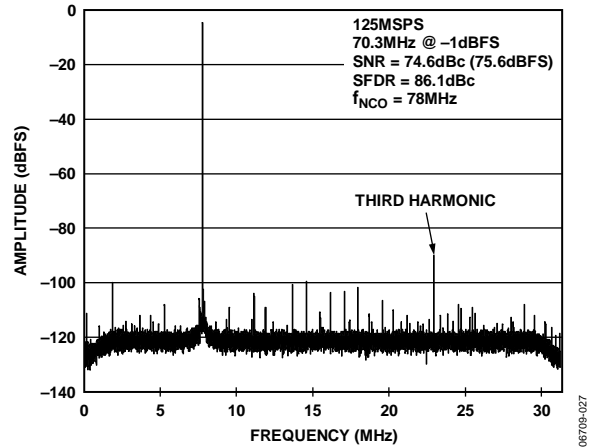

Figure 28. AD6655-125 Single-Tone FFT with $f_{IN} = 70.3\text{ MHz}$, $f_{NCO} = 78\text{ MHz}$

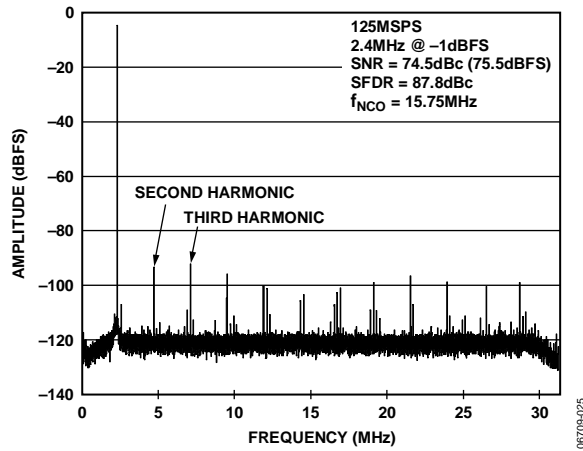

Figure 26. AD6655-125 Single-Tone FFT with $f_{IN} = 2.4\text{ MHz}$, $f_{NCO} = 15.75\text{ MHz}$

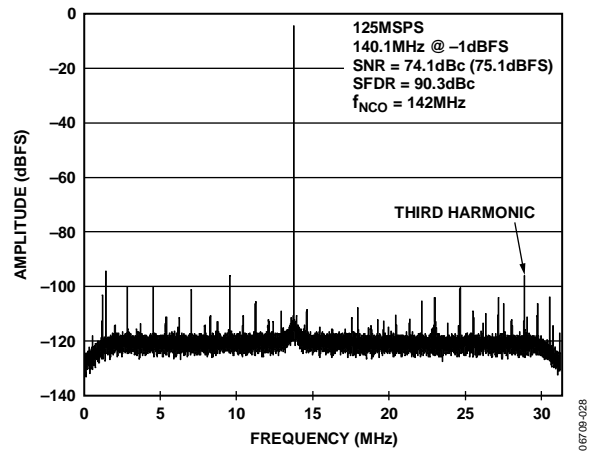

Figure 29. AD6655-125 Single-Tone FFT with $f_{IN} = 140.1\text{ MHz}$, $f_{NCO} = 142\text{ MHz}$

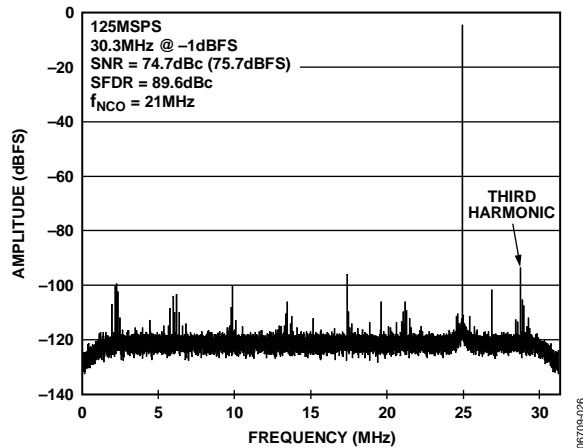

Figure 27. AD6655-125 Single-Tone FFT with $f_{IN} = 30.3\text{ MHz}$, $f_{NCO} = 21\text{ MHz}$

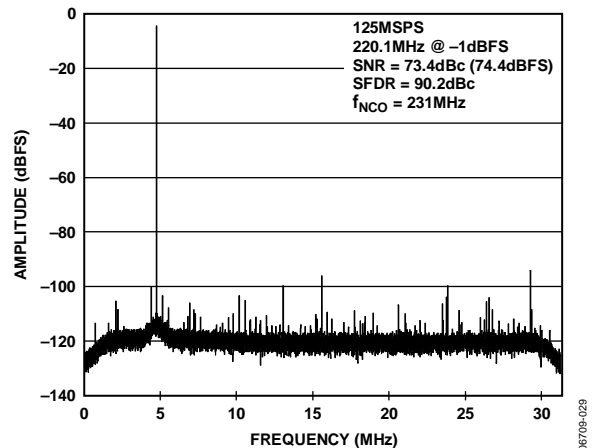

Figure 30. AD6655-125 Single-Tone FFT with $f_{IN} = 220.1\text{ MHz}$, $f_{NCO} = 231\text{ MHz}$

AD6655

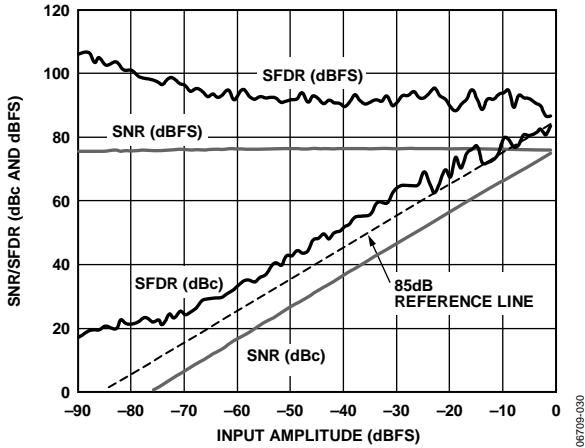

Figure 31. AD6655-150 Single-Tone SNR/SFDR vs. Input Amplitude (A_{IN}) with $f_{IN} = 2.4 \text{ MHz}$, $f_{NCO} = 18.75 \text{ MHz}$

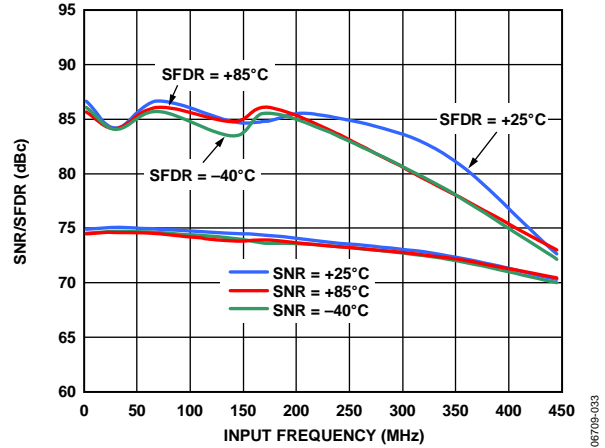

Figure 34. AD6655-125 Single-Tone SNR/SFDR vs. Input Frequency (f_{IN}) and Temperature with $DRVDD = 3.3 \text{ V}$

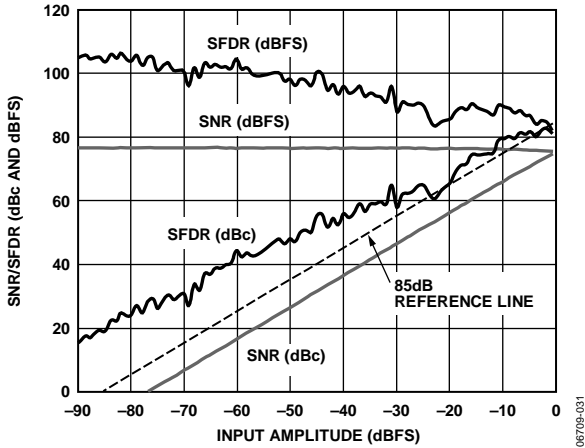

Figure 32. AD6655-150 Single-Tone SNR/SFDR vs. Input Amplitude (A_{IN}) with $f_{IN} = 98.12 \text{ MHz}$, $f_{NCO} = 100.49 \text{ MHz}$

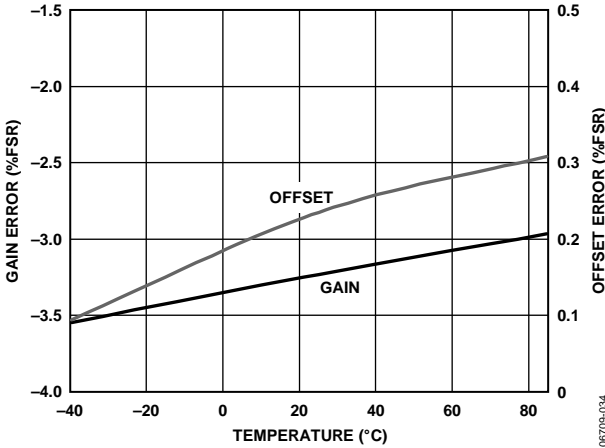

Figure 35. AD6655-150 Gain and Offset vs. Temperature

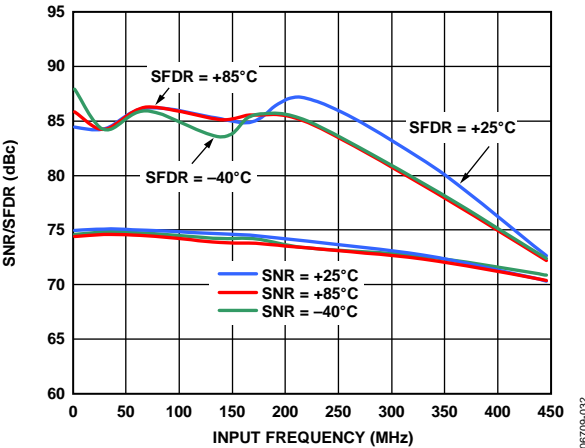

Figure 33. AD6655-125 Single-Tone SNR/SFDR vs. Input Frequency (f_{IN}) and Temperature with $DRVDD = 1.8 \text{ V}$

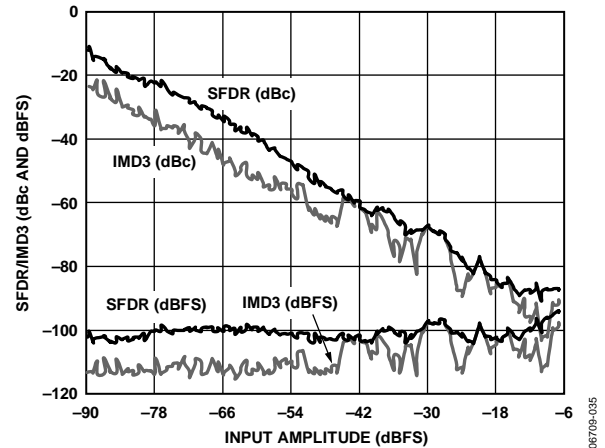

Figure 36. AD6655-150 Two-Tone SFDR/IMD3 vs. Input Amplitude (A_{IN}) with $f_{IN1} = 29.12 \text{ MHz}$, $f_{IN2} = 32.12 \text{ MHz}$, $f_S = 150 \text{ MSPS}$, $f_{NCO} = 22 \text{ MHz}$

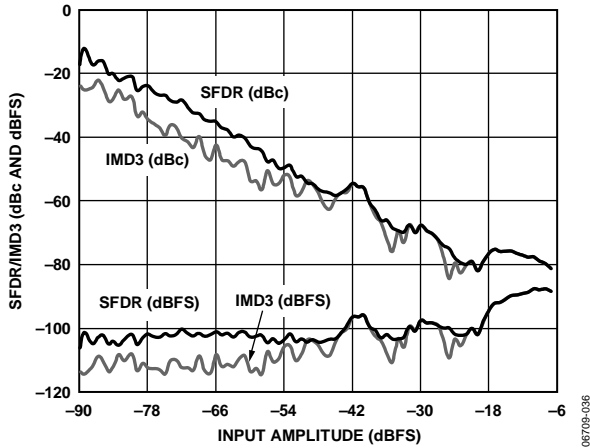

Figure 37. AD6655-150 Two-Tone SFDR/IMD3 vs. Input Amplitude (A_{IN}) with $f_{IN1} = 169.12$ MHz, $f_{IN2} = 172.12$ MHz, $f_S = 150$ MSPS, $f_{NCO} = 177$ MHz

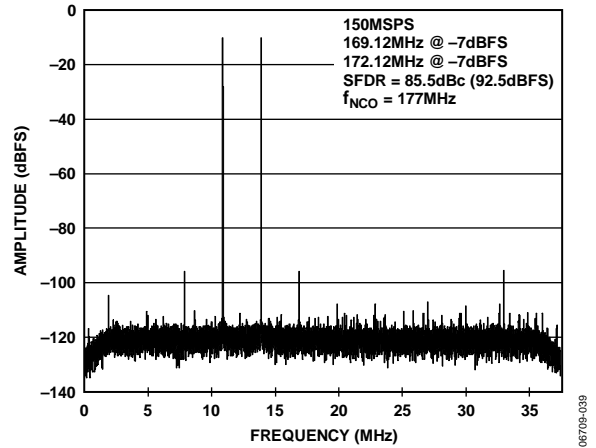

Figure 40. AD6655-150 Two Tone FFT with $f_{IN1} = 169.12$ MHz, $f_{IN2} = 172.12$ MHz, $f_S = 150$ MSPS, $f_{NCO} = 177$ MHz

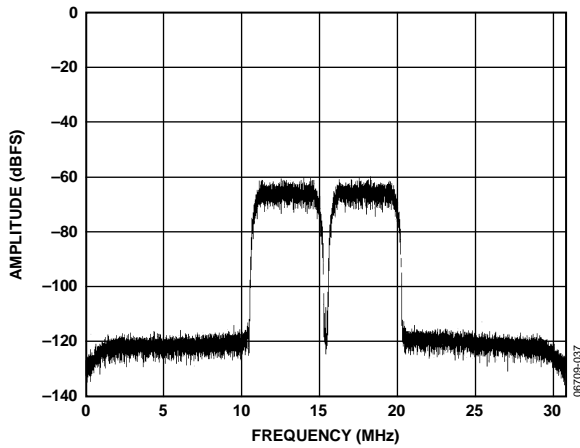

Figure 38. AD6655-125, Two 64k WCDMA Carriers with $f_{IN} = 170$ MHz, $f_S = 122.88$ MHz, $f_{NCO} = 168.96$ MHz

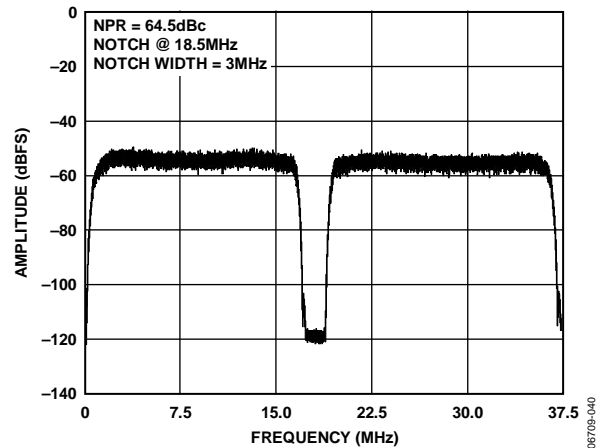

Figure 41. AD6655-150 Noise Power Ratio (NPR)

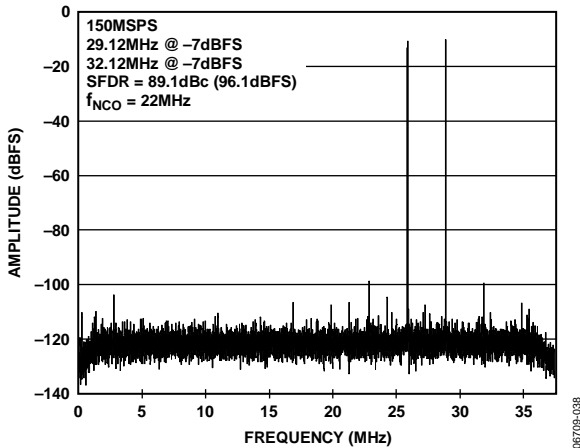

Figure 39. AD6655-150 Two-Tone FFT with $f_{IN1} = 29.12$ MHz, $f_{IN2} = 32.12$ MHz, $f_S = 150$ MSPS, $f_{NCO} = 22$ MHz

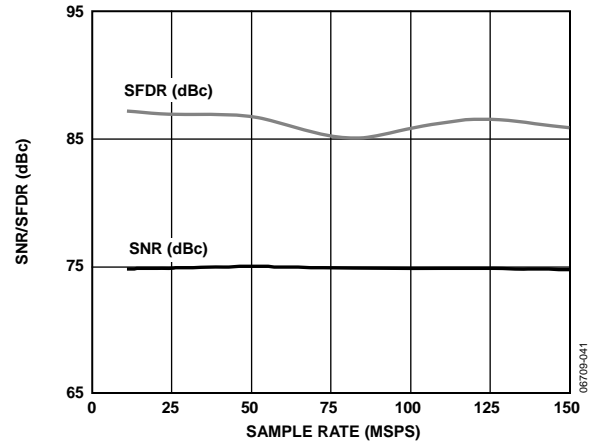

Figure 42. AD6655-150 Single-Tone SNR/SFDR vs. Sample Rate (f_S) with $f_{IN} = 2.3$ MHz

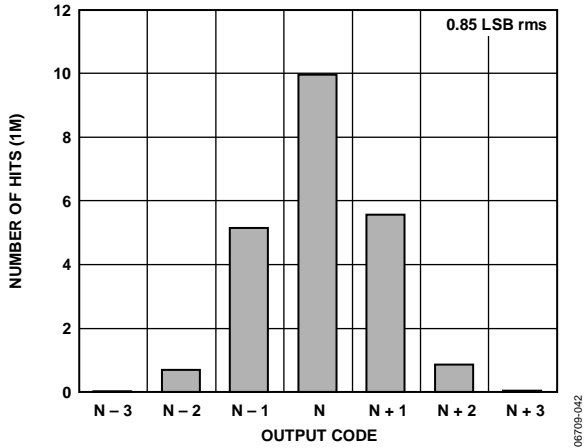

Figure 43. AD6655 Grounded Input Histogram

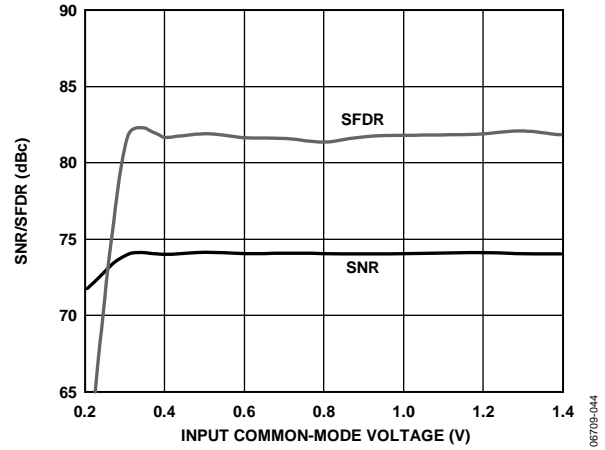

Figure 45. AD6655-150 SNR/SFDR vs. Input Common Mode (V_{CM}) with $f_{IN} = 30.3$ MHz, $f_{NCO} = 45$ MHz

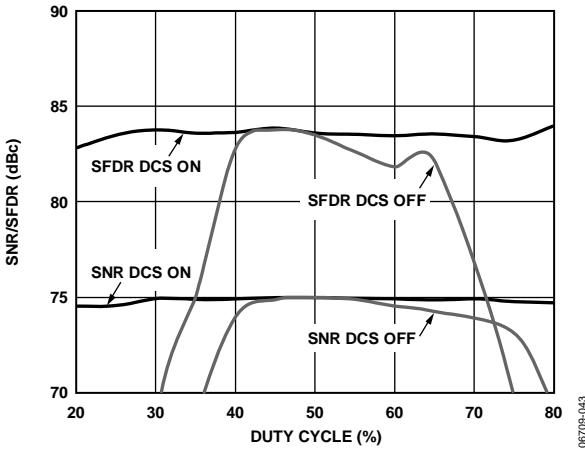

Figure 44. AD6655-150 SNR/SFDR vs. Duty Cycle with $f_{IN} = 30.3$ MHz, $f_{NCO} = 45$ MHz

THEORY OF OPERATION

The AD6655 has two analog input channels, two decimating channels, and two digital output channels. The intermediate frequency (IF) input signal passes through several stages before appearing at the output port(s) as a filtered, decimated digital signal.

The dual ADC design can be used for diversity reception of signals, where the ADCs operate identically on the same carrier but from two separate antennae. The ADCs can also be operated with independent analog inputs. The user can sample any $f_s/2$ frequency segment from dc to 150 MHz using appropriate low-pass or band-pass filtering at the ADC inputs with little loss in ADC performance. Operation to 450 MHz analog input is permitted but occurs at the expense of increased ADC noise and distortion.

In nondiversity applications, the AD6655 can be used as a base-band receiver, where one ADC is used for I input data, and the other is used for Q input data.

Synchronization capability is provided to allow synchronized timing between multiple channels or multiple devices. The NCO phase can be set to produce a known offset relative to another channel or device.

Programming and control of the AD6655 are accomplished using a 3-bit SPI-compatible serial interface.

ADC ARCHITECTURE

AD6655 architecture consists of a front-end sample-and-hold amplifier (SHA) followed by a pipelined, switched-capacitor ADC. The quantized outputs from each stage are combined into a final 14-bit result in the digital correction logic. The pipelined architecture permits the first stage to operate on a new input sample and the remaining stages to operate on the preceding samples. Sampling occurs on the rising edge of the clock.

Each stage of the pipeline, excluding the last, consists of a low resolution flash ADC connected to a switched-capacitor digital-to-analog converter (DAC) and an interstage residue amplifier (MDAC). The residue amplifier magnifies the difference between the reconstructed DAC output and the flash input for the next stage in the pipeline. One bit of redundancy is used in each stage to facilitate digital correction of flash errors. The last stage simply consists of a flash ADC.

The input stage of each channel contains a differential SHA that can be ac- or dc-coupled in differential or single-ended modes. The output staging block aligns the data, corrects errors, and passes the data to the output buffers. The output buffers are powered from a separate supply, allowing adjustment of the output voltage swing. During power-down, the output buffers go into a high impedance state.

ANALOG INPUT CONSIDERATIONS

The analog input to the AD6655 is a differential switched-capacitor SHA that has been designed for optimum performance while processing a differential input signal.

The clock signal alternatively switches the SHA between sample mode and hold mode (see Figure 46). When the SHA is switched into sample mode, the signal source must be capable of charging the sample capacitors and settling within 1/2 of a clock cycle.

A small resistor in series with each input can help reduce the peak transient current required from the output stage of the driving source. A shunt capacitor can be placed across the inputs to provide dynamic charging currents. This passive network creates a low-pass filter at the ADC input; therefore, the precise values are dependent on the application.

In IF undersampling applications, any shunt capacitors should be reduced. In combination with the driving source impedance, the shunt capacitors limit the input bandwidth. Refer to Application Note AN-742, *Frequency Domain Response of Switched-Capacitor ADCs*; Application Note AN-827, *A Resonant Approach to Interfacing Amplifiers to Switched-Capacitor ADCs*; and the *Analog Dialogue* article, “Transformer-Coupled Front-End for Wideband A/D Converters,” for more information on this subject (see www.analog.com). In general, the precise values are dependent on the application.

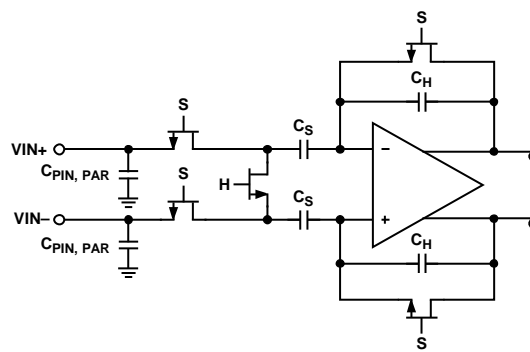

Figure 46. Switched-Capacitor SHA Input

For best dynamic performance, the source impedances driving V_{IN+} and V_{IN-} should be matched such that common-mode settling errors are symmetrical. These errors are reduced by the common-mode rejection of the ADC.

An internal differential reference buffer creates positive and negative reference voltages that define the input span of the ADC core. The output common mode of the reference buffer is set to V_{CMREF} (approximately 1.6 V).

Input Common Mode

The analog inputs of the AD6655 are not internally dc biased. In ac-coupled applications, the user must provide this bias externally. Setting the device so that $V_{CM} = 0.55 \times AV_{DD}$ is recommended for optimum performance, but the device functions over a wider range with reasonable performance (see Figure 45).

AD6655

An on-board common-mode voltage reference is included in the design and is available from the CML pin. Optimum performance is achieved when the common-mode voltage of the analog input is set by the CML pin voltage (typically $0.55 \times AVDD$).

Differential Input Configurations

Optimum performance is achieved while driving the AD6655 in a differential input configuration. For baseband applications, the [AD8138](#), [ADA4937-2](#), and [ADA4938-2](#) differential drivers provide excellent performance and a flexible interface to the ADC. The output common-mode voltage of the AD8138 is easily set with the CML pin of the AD6655 (see Figure 47), and the driver can be configured in a Sallen-Key filter topology to provide band limiting of the input signal.

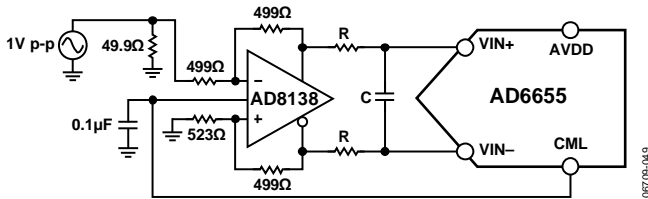

Figure 47. Differential Input Configuration Using the AD8138

For baseband applications where SNR is a key parameter, differential transformer coupling is the recommended input configuration. An example is shown in Figure 48. To bias the analog input, the CML voltage can be connected to the center tap of the secondary winding of the transformer.

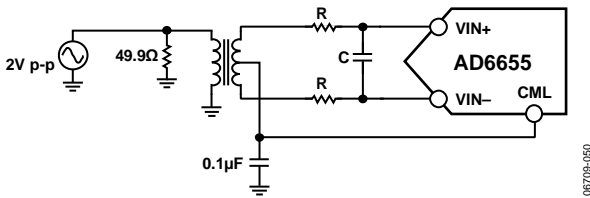

Figure 48. Differential Transformer-Coupled Configuration

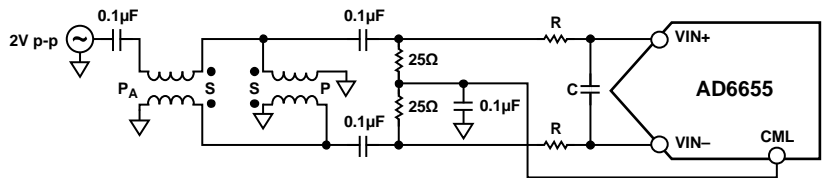

Figure 49. Differential Double Balun Input Configuration

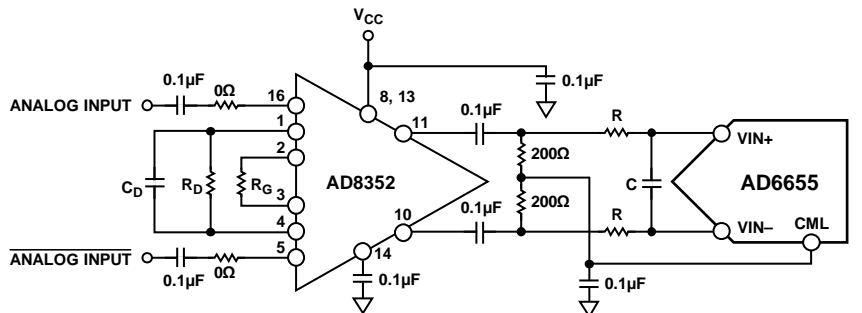

Figure 50. Differential Input Configuration Using the AD8352

The signal characteristics must be considered when selecting a transformer. Most RF transformers saturate at frequencies below a few megahertz (MHz). Excessive signal power can also cause core saturation, which leads to distortion.

At input frequencies in the second Nyquist zone and above, the noise performance of most amplifiers is not adequate to achieve the true SNR performance of the AD6655. For applications where SNR is a key parameter, differential double balun coupling is the recommended input configuration (see Figure 49).

An alternative to using a transformer-coupled input at frequencies in the second Nyquist zone is to use the AD8352 differential driver is shown in Figure 50. See the [AD8352](#) data sheet for more information. In addition, if the application requires an amplifier with variable gain, the [AD8375](#) or [AD8376](#) digital variable gain amplifiers (DVGAs) provide good performance driving the AD6655.

In any configuration, the value of the shunt capacitor, C, is dependent on the input frequency and source impedance and may need to be reduced or removed. Table 14 displays recommended values to set the RC network. However, these values are dependent on the input signal and should be used only as a starting guide.

Table 14. Example RC Network

Frequency Range (MHz)	R Series (Ω, Each)	C Differential (pF)
0 to 70	33	15
70 to 200	33	5
200 to 300	15	5
>300	15	Open

Single-Ended Input Configuration

A single-ended input can provide adequate performance in cost-sensitive applications. In this configuration, SFDR and distortion performance degrade due to the large input common-mode swing. If the source impedances on each input are matched, there should be little effect on SNR performance. Figure 51 shows a typical single-ended input configuration.

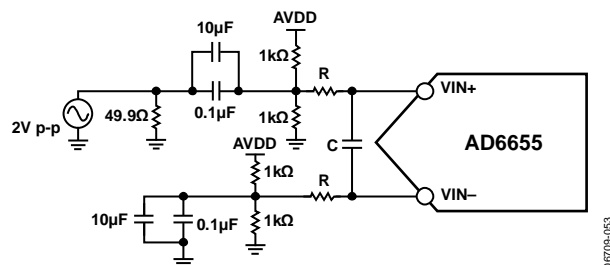

Figure 51. Single-Ended Input Configuration

VOLTAGE REFERENCE

A stable and accurate voltage reference is built into the AD6655. The input range can be adjusted by varying the reference voltage applied to the AD6655, using either the internal reference or an externally applied reference voltage. The input span of the ADC tracks reference voltage changes linearly. The various reference modes are summarized in the sections that follow. The Reference Decoupling section describes the best practices PCB layout of the reference.

Internal Reference Connection

A comparator within the AD6655 detects the potential at the SENSE pin and configures the reference into four possible modes, which are summarized in Table 15. If SENSE is grounded, the reference amplifier switch is connected to the internal resistor divider (see Figure 52), setting VREF to 1.0 V. Connecting the SENSE pin to VREF switches the reference amplifier output to the SENSE pin, completing the loop and providing a 0.5 V reference output. If a resistor divider is connected externally to the chip, as shown in Figure 53, the switch again sets to the SENSE pin.

This puts the reference amplifier in a noninverting mode with the VREF output defined as follows:

$$VREF = 0.5 \times \left(1 + \frac{R2}{R1} \right)$$

The input range of the ADC always equals twice the voltage at the reference pin for either an internal or an external reference.

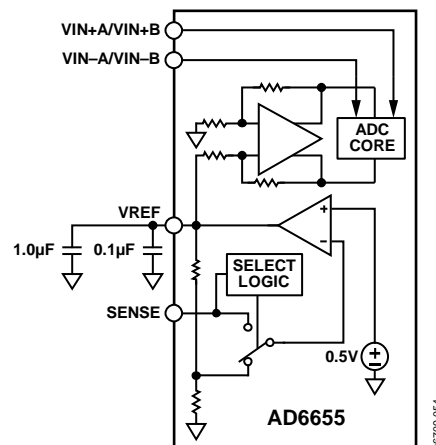

Figure 52. Internal Reference Configuration

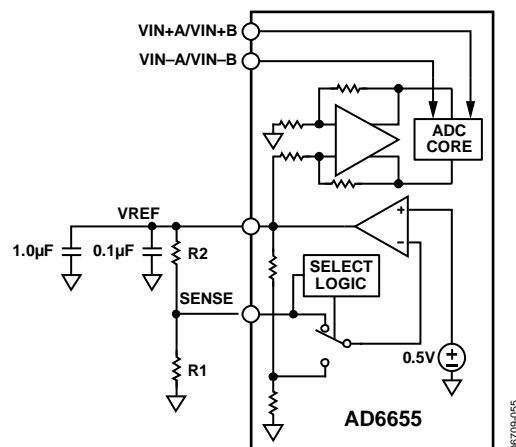

Figure 53. Programmable Reference Configuration

Table 15. Reference Configuration Summary

Selected Mode	SENSE Voltage	Resulting VREF (V)	Resulting Differential Span (V p-p)
External Reference	AVDD	N/A	2 × external reference
Internal Fixed Reference	VREF	0.5	1.0
Programmable Reference	0.2 V to VREF	$0.5 \times \left(1 + \frac{R2}{R1} \right)$ (see Figure 53)	2 × VREF
Internal Fixed Reference	AGND to 0.2 V	1.0	2.0

AD6655

If the internal reference of the AD6655 is used to drive multiple converters to improve gain matching, the loading of the reference by the other converters must be considered. Figure 54 depicts how the internal reference voltage is affected by loading.

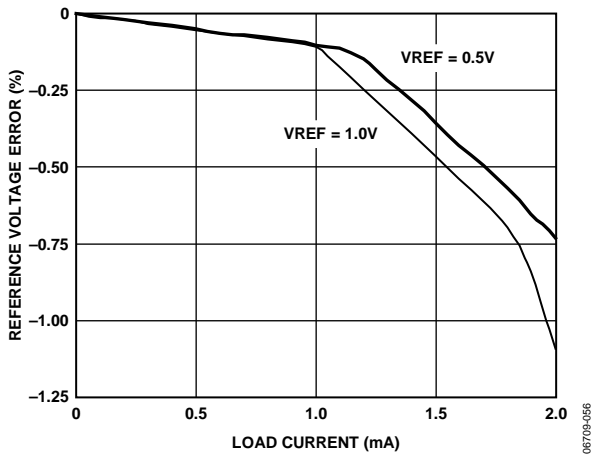

Figure 54. VREF Accuracy vs. Load

External Reference Operation

The use of an external reference may be necessary to enhance the gain accuracy of the ADC or improve thermal drift characteristics. Figure 55 shows the typical drift characteristics of the internal reference in both 1.0 V and 0.5 V modes.

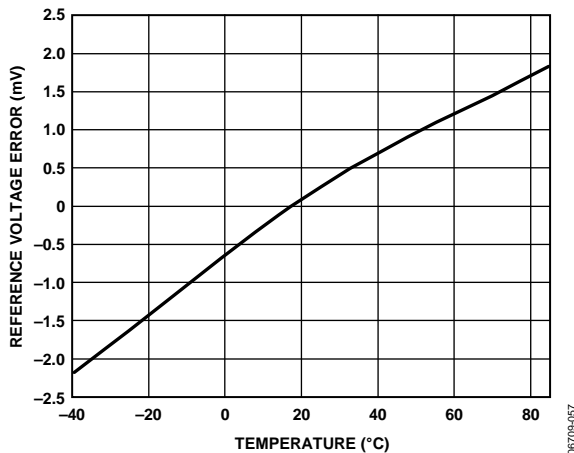

Figure 55. Typical VREF Drift

When the SENSE pin is tied to AVDD, the internal reference is disabled, allowing the use of an external reference. An internal reference buffer loads the external reference with an equivalent 6 kΩ load (see Figure 18). The internal buffer generates the positive and negative full-scale references for the ADC core. Therefore, the external reference must be limited to a maximum of 1.0 V.

CLOCK INPUT CONSIDERATIONS

For optimum performance, the AD6655 sample clock inputs, CLK+ and CLK-, should be clocked with a differential signal. The signal is typically ac-coupled into the CLK+ and CLK- pins via a transformer or capacitors. These pins are biased internally (see Figure 56) and require no external bias.

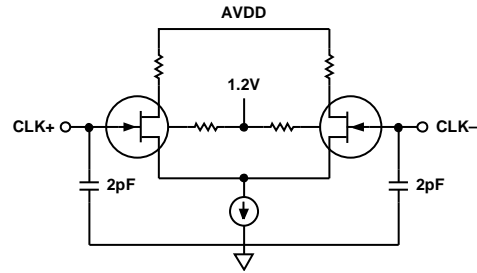

Figure 56. Equivalent Clock Input Circuit

Clock Input Options

The AD6655 has a very flexible clock input structure. Clock input can be a CMOS, LVDS, LVPECL, or sine wave signal. Regardless of the type of signal being used, clock source jitter is of the most concern, as described in the Jitter Considerations section.

Figure 57 and Figure 58 show two preferred methods for clocking the AD6655 (at clock rates to up to 625 MHz). A low jitter clock source is converted from a single-ended signal to a differential signal using an RF transformer. The back-to-back Schottky diodes across the transformer secondary limit clock excursions into the AD6655 to approximately 0.8 V p-p differential. This helps prevent the large voltage swings of the clock from feeding through to other portions of the AD6655, while preserving the fast rise and fall times of the signal, which are critical to a low jitter performance.

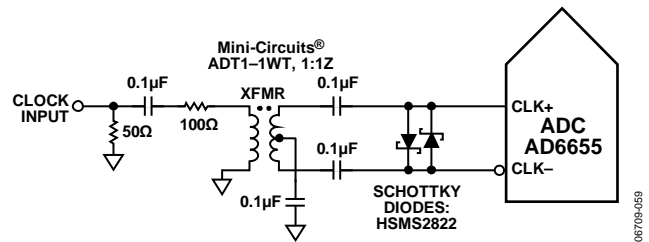

Figure 57. Transformer Coupled Differential Clock (Up to 200 MHz)

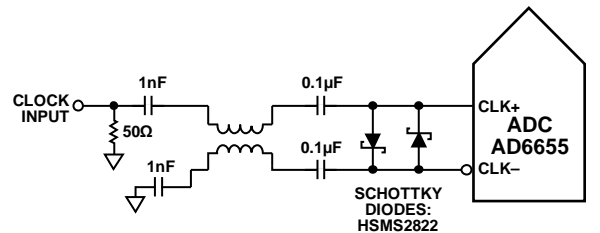

Figure 58. Balun-Coupled Differential Clock (Up to 625 MHz)

If a low jitter clock source is not available, another option is to ac couple a differential PECL signal to the sample clock input pins as shown in Figure 59. The AD9510/AD9511/AD9512/AD9513/AD9514/AD9515/AD9516 clock drivers offer excellent jitter performance.

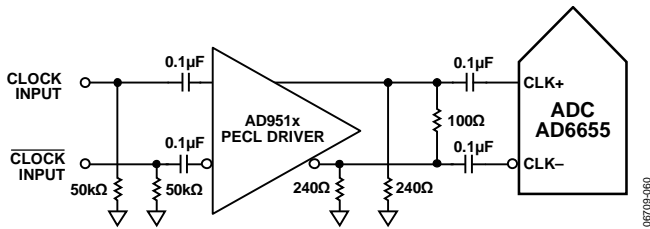

Figure 59. Differential PECL Sample Clock (Up to 625 MHz)

A third option is to ac-couple a differential LVDS signal to the sample clock input pins, as shown in Figure 60. The AD9510/AD9511/AD9512/AD9513/AD9514/AD9515/AD9516 clock drivers offer excellent jitter performance.

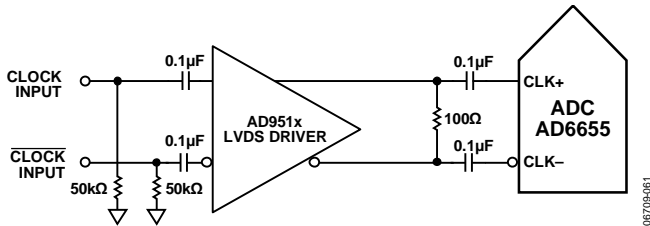

Figure 60. Differential LVDS Sample Clock (Up to 625 MHz)

In some applications, it may be acceptable to drive the sample clock inputs with a single-ended CMOS signal. In such applications, the CLK+ pin should be driven directly from a CMOS gate, and the CLK- pin should be bypassed to ground with a 0.1 µF capacitor in parallel with a 39 kΩ resistor (see Figure 61). CLK+ can be driven directly from a CMOS gate. Although the CLK+ input circuit supply is AVDD (1.8 V), this input is designed to withstand input voltages of up to 3.6 V, making the selection of the drive logic voltage very flexible.

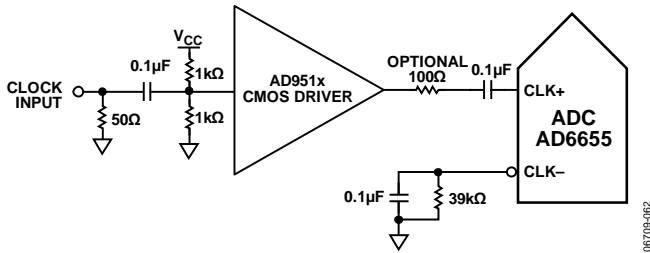

Figure 61. Single-Ended 1.8 V CMOS Sample Clock (Up to 150 MSPS)

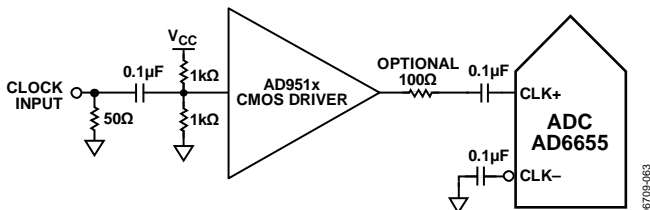

Figure 62. Single-Ended 3.3 V CMOS Sample Clock (Up to 150 MSPS)

Input Clock Divider

The AD6655 contains an input clock divider with the ability to divide the input clock by integer values between 1 and 8. If a divide ratio other than 1 is selected, the duty cycle stabilizer is automatically enabled.

The AD6655 clock divider can be synchronized using the external SYNC input. Bit 1 and Bit 2 of Register 0x100 allow the clock divider to be resynchronized on every SYNC signal or only on the first SYNC signal after the register is written. A valid SYNC causes the clock divider to reset to its initial state. This synchronization feature allows multiple parts to have their clock dividers aligned to guarantee simultaneous input sampling.

Clock Duty Cycle

Typical high speed ADCs use both clock edges to generate a variety of internal timing signals and, as a result, may be sensitive to clock duty cycle. Commonly, a ±5% tolerance is required on the clock duty cycle to maintain dynamic performance characteristics.

The AD6655 contains a duty cycle stabilizer (DCS) that retimes the nonsampling (falling) edge, providing an internal clock signal with a nominal 50% duty cycle. This allows the user to provide a wide range of clock input duty cycles without affecting the performance of the AD6655. Noise and distortion performance are nearly flat for a wide range of duty cycles with the DCS on, as shown in Figure 44.

Jitter on the rising edge of the input clock is still of paramount concern and is not easily reduced by the internal stabilization circuit. The duty cycle control loop does not function for clock rates less than 20 MHz nominally. The loop has a time constant associated with it that must be considered when the clock rate can change dynamically. A wait time of 1.5 µs to 5 µs is required after a dynamic clock frequency increase or decrease before the DCS loop is relocked to the input signal. During the time period that the loop is not locked, the DCS loop is bypassed, and internal device timing is dependent on the duty cycle of the input clock signal. In such applications, it may be appropriate to disable the duty cycle stabilizer. In all other applications, enabling the DCS circuit is recommended to maximize ac performance.

Jitter Considerations

High speed, high resolution ADCs are sensitive to the quality of the clock input. The degradation in SNR at a given input frequency (f_{IN}) due to jitter (t_j) can be calculated by

$$SNR_{HF} = -10 \log[(2\pi \times f_{IN} \times t_{RMS})^2 + 10^{(-SNR_{LF}/10)}]$$

In the equation, the rms aperture jitter represents the root-mean-square of all jitter sources, which include the clock input, the analog input signal, and the ADC aperture jitter specification. IF undersampling applications are particularly sensitive to jitter, as shown in Figure 63.

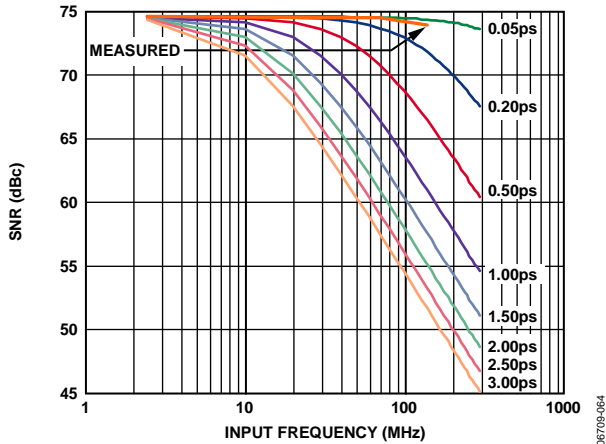

Figure 63. SNR vs. Input Frequency and Jitter

The clock input should be treated as an analog signal in cases where aperture jitter may affect the dynamic range of the AD6655. Power supplies for clock drivers should be separated from the ADC output driver supplies to avoid modulating the clock signal with digital noise. Low jitter, crystal-controlled oscillators make the best clock sources. If the clock is generated from another type of source (by gating, dividing, or another method), it should be retimed by the original clock at the last step.

Refer to Application Note AN501 and Application Note AN756 for more information about jitter performance as it relates to ADCs (see www.analog.com).

POWER DISSIPATION AND STANDBY MODE

As shown in Figure 64 through Figure 67, the power dissipated by the AD6655 is proportional to its sample rate. In CMOS output mode, the digital power dissipation is determined primarily by the strength of the digital drivers and the load on each output bit. The maximum DRVDD current (I_{DRVDD}) can be calculated by

$$I_{DRVDD} = V_{DRVDD} \times C_{LOAD} \times f_{CLK} \times N$$

where N is the number of output bits (30, in the case of the AD6655, assuming the FD bits are inactive).

This maximum current occurs when every output bit switches on every clock cycle, that is, a full-scale square wave at the Nyquist frequency of $f_{CLK}/2$. In practice, the DRVDD current is established by the average number of output bits switching, which is determined by the sample rate and the characteristics of the analog input signal. Reducing the capacitive load presented to the output drivers can minimize digital power consumption. The data in Figure 64 through Figure 67 was taken using the same operating conditions as those used for the Typical Performance Characteristics, with a 5 pF load on each output driver.

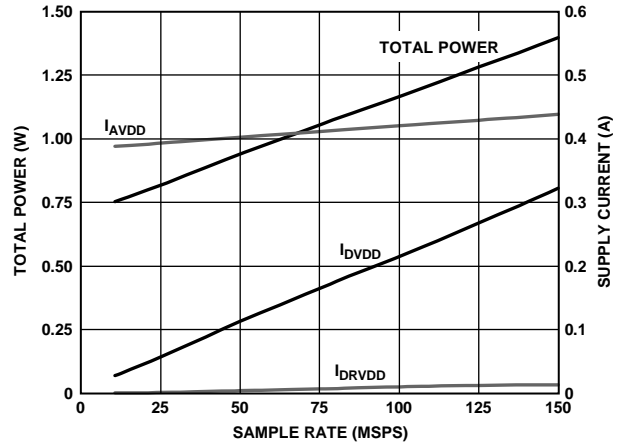

Figure 64. AD6655-150 Power and Current vs. Sample Rate

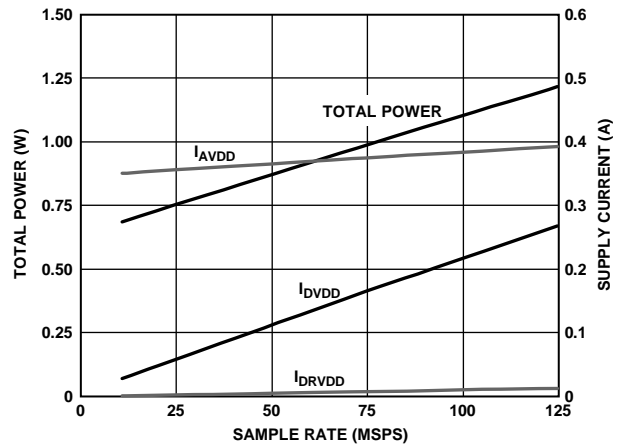

Figure 65. AD6655-125 Power and Current vs. Sample Rate

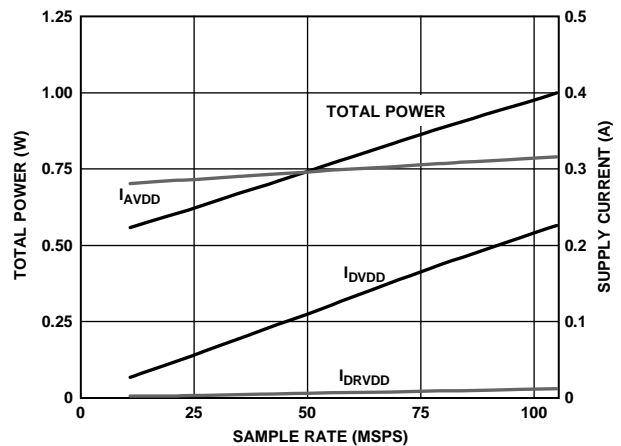

Figure 66. AD6655-105 Power and Current vs. Sample Rate

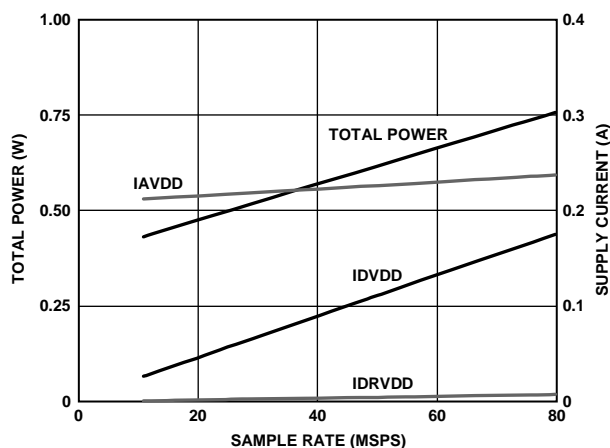

Figure 67. AD6655-80 Power and Current vs. Sample Rate

By asserting PDWN (either through the SPI port or by asserting the PDWN pin high), the AD6655 is placed in power-down mode. In this state, the ADC typically dissipates 2.5 mW. During power-down, the output drivers are placed in a high impedance state. Asserting the PDWN pin low returns the AD6655 to its normal operating mode. Note that PDWN is referenced to the digital output driver supply (DRVDD) and should not exceed that supply voltage. PDWN can be driven with 1.8 V logic, even when DRVDD is at 3.3 V.

Low power dissipation in power-down mode is achieved by shutting down the reference, reference buffer, biasing networks, and clock. Internal capacitors are discharged when entering power-down mode and then must be recharged when returning to normal operation. As a result, wake-up time is related to the time spent in power-down mode, and shorter power-down cycles result in proportionally shorter wake-up times.

When using the SPI port interface, the user can place the ADC in power-down mode or standby mode. Standby mode allows the user to keep the internal reference circuitry powered when faster wake-up times are required. See the Memory Map Register Description section and Application Note AN-877, *Interfacing to High Speed ADCs via SPI* at www.analog.com for additional details.

DIGITAL OUTPUTS

The AD6655 output drivers can be configured to interface with 1.8 V to 3.3 V CMOS logic families by matching DRVDD to the digital supply of the interfaced logic. Alternatively, the AD6655 outputs can be configured for either ANSI LVDS or reduced drive LVDS using a 1.8 V DRVDD supply.

In CMOS output mode, the output drivers are sized to provide sufficient output current to drive a wide variety of logic families. However, large drive currents tend to cause current glitches on the supplies that may affect converter performance. Applica-

tions requiring the ADC to drive large capacitive loads or large fanouts may require external buffers or latches.

The output data format can be selected for either offset binary or twos complement by setting the SCLK/DFS pin when operating in the external pin mode (see Table 16). As detailed in Application Note AN-877, *Interfacing to High Speed ADCs via SPI*, the data format can be selected for offset binary, twos complement, or gray code when using the SPI control.

Table 16. SCLK/DFS Mode Selection (External Pin Mode)

Voltage at Pin	SCLK/DFS	SDIO/DCS
AGND (default)	Offset binary	DCS disabled
AVDD	Twos complement	DCS enabled

Digital Output Enable Function (OEB)

The AD6655 has a flexible three-state ability for the digital output pins. The three-state mode is enabled using the SMI SDO/OEB pin or through the SPI interface. If the SMI SDO/OEB pin is low, the output data drivers are enabled. If the SMI SDO/OEB pin is high, the output data drivers are placed in a high impedance state. This OEB function is not intended for rapid access to the data bus. Note that OEB is referenced to the digital output driver supply (DRVDD) and should not exceed that supply voltage. OEB can be driven with 1.8 V logic even when DRVDD is at 3.3 V.

When using the SPI interface, the data and fast detect outputs of each channel can be independently three-stated by using the output enable bar bit (Bit 4) in Register 0x14.

Interleaved CMOS Mode

Setting Bit 5 in Register 0x14 enables interleaved CMOS output mode. In this mode, output data is routed through Port A with the ADC Channel A output data present on the rising edge of DCO and the ADC Channel B output data present on the falling edge of DCO.

Timing

The AD6655 provides latched data with a pipeline delay that is dependent on which of the digital back end features are enabled. Data outputs are available one propagation delay (t_{PD}) after the rising edge of the clock signal.

The length of the output data lines and loads placed on them should be minimized to reduce transients within the AD6655. These transients can degrade converter dynamic performance.

The lowest typical conversion rate of the AD6655 is 10 MSPS. At clock rates below 10 MSPS, dynamic performance may degrade.

Data Clock Output (DCO)

The AD6655 also provides data clock output (DCO) intended for capturing the data in an external register. Figure 2 through Figure 6 show a graphical timing description of the AD6655 output modes.

AD6655

Table 17. Output Data Format

Input (V)	Condition (V)	Offset Binary Output Mode	Twos Complement Mode	OR
VIN+ – VIN–	< –VREF – 0.5 LSB	00 0000 0000 0000	10 0000 0000 0000	1
VIN+ – VIN–	= –VREF	00 0000 0000 0000	10 0000 0000 0000	0
VIN+ – VIN–	= 0	10 0000 0000 0000	00 0000 0000 0000	0
VIN+ – VIN–	= +VREF – 1.0 LSB	11 1111 1111 1111	01 1111 1111 1111	0
VIN+ – VIN–	> +VREF – 0.5 LSB	11 1111 1111 1111	01 1111 1111 1111	1

DIGITAL DOWNCONVERTER

The AD6655 includes a digital processing section that provides filtering and reduces the output data rate. This digital processing section includes a numerically controlled oscillator (NCO), a half-band decimating filter, an FIR filter, and a second coarse NCO ($f_{\text{ADC}}/8$ fixed value) for output frequency translation. Each of these processing blocks (except the decimating half-band filter) has control lines that allow it to be independently enabled and disabled to provide the desired processing function. The digital downconverter can be configured to output either real data or complex output data. These blocks can be configured in five recommended combinations to implement different signal processing functions.

DOWNCONVERTER MODES

Table 18 details the recommended downconverter modes of operation in the AD6655.

Table 18. Downconverter Modes

Mode	NCO/Filter	Output Type
1	Half-band filter only	Real
2	Half-band filter and FIR filter	Real
3	NCO and half-band filter	Complex
4	NCO, half-band filter, and FIR filter	Complex
5	NCO, half-band filter, FIR filter, and $f_{\text{ADC}}/8$ NCO	Real

NUMERICALLY CONTROLLED OSCILLATOR (NCO)

Frequency translation is accomplished with an NCO. Each of the two processing channels shares a common NCO. Amplitude and phase dither can be enabled on chip to improve the noise and spurious performance of the NCO. A phase offset word is available to create a known phase relationship between multiple AD6655s.

Because the decimation filter prevents usage of half the Nyquist spectrum, a means is needed to translate the sampled input spectrum into the usable range of the decimation filter. To achieve this, a 32-bit, fine tuning, complex NCO is provided. This NCO/mixer allows the input spectrum to be tuned to dc, where it can be effectively filtered by the subsequent filter blocks to prevent aliasing.

HALF-BAND DECIMATING FILTER AND FIR FILTER

The goal of the AD6655 digital filter block is to allow the sample rate to be reduced by a factor of 2 while rejecting aliases that fall into the band of interest. The half-band filter is designed to operate as either a low-pass or high-pass filter and to provide greater than 100 dB of alias protection for 22% of the input rate of the structure. For an ADC sample rate of 150 MSPS, this provides

a maximum usable bandwidth of 16.5 MHz when using the filter in real mode (NCO bypassed) or a maximum usable bandwidth of 33.0 MHz when using the filter in the complex mode (NCO enabled).

The optional fixed-coefficient FIR filter provides additional filtering capability to sharpen the half-band roll-off to enhance the alias protection. It removes the negative frequency images to avoid aliasing negative frequencies for real outputs.

$f_{\text{ADC}}/8$ FIXED-FREQUENCY NCO

A fixed $f_{\text{ADC}}/8$ NCO is provided to translate the filtered, decimated signal from dc to $f_{\text{ADC}}/8$ to allow a real output. Figure 68 to Figure 71 show an example of a 20 MHz input as it is processed by the blocks of the AD6655.

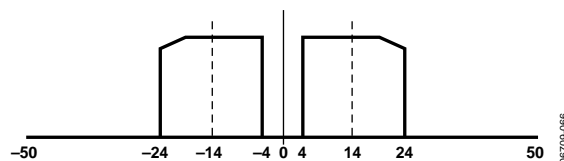

Figure 68. Example AD6655 Real 20 MHz Bandwidth Input Signal Centered at 14 MHz ($f_{\text{ADC}} = 100$ MHz)

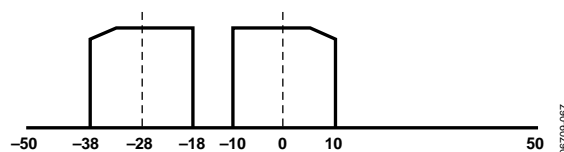

Figure 69. Example AD6655 20 MHz Bandwidth Input Signal Tuned to DC Using the NCO (NCO Frequency = 14 MHz)

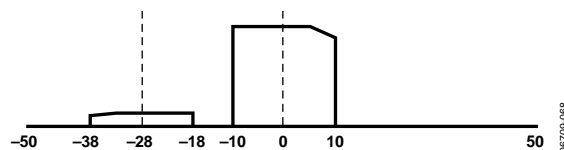

Figure 70. Example AD6655 20 MHz Bandwidth Input Signal with the Negative Image Filtered by the Half-Band and FIR Filters

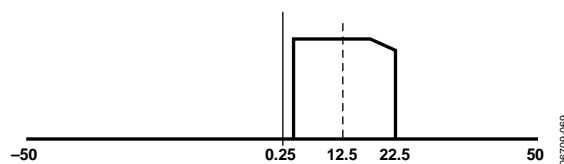

Figure 71. Example AD6655 20 MHz Bandwidth Input Signal Tuned to $f_{\text{ADC}}/8$ for Real Output

NUMERICALLY CONTROLLED OSCILLATOR (NCO)

FREQUENCY TRANSLATION

This processing stage comprises a digital tuner consisting of a 32-bit complex numerically controlled oscillator (NCO). The two channels of the AD6655 share a single NCO. The NCO is optional and can be bypassed by clearing Bit 0 of Register 0x11D. This NCO block accepts a real input from the ADC stage and outputs a frequency translated complex (I and Q) output.

The NCO frequency is programmed in Register 0x11E, Register 0x11F, Register 0x120, and Register 0x121. These four 8-bit registers make up a 32-bit unsigned frequency programming word. Frequencies between $-\text{CLK}/2$ and $+\text{CLK}/2$ are represented using the following frequency words:

- 0x8000 0000 represents a frequency given by $-\text{CLK}/2$.
- 0x0000 0000 represents dc (frequency = 0 Hz).
- 0x7FFF FFFF represents $\text{CLK}/2 - \text{CLK}/2^{32}$.

Use the following equation to calculate the NCO frequency:

$$NCO_FREQ = 2^{32} \times \frac{\text{Mod}(f, f_{CLK})}{f_{CLK}}$$

where:

NCO_FREQ is a 32-bit two's complement number representing the NCO frequency register.

f is the desired carrier frequency in hertz (Hz).

f_{CLK} is the AD6655 ADC clock rate in hertz (Hz).

NCO SYNCHRONIZATION

The AD6655 NCOs within a single part or across multiple parts can be synchronized using the external SYNC input. Bit 3 and Bit 4 of Register 0x100 allow the NCO to be resynchronized on every SYNC signal or only on the first SYNC signal after the register is written. A valid SYNC causes the NCO to restart at the programmed phase offset value.

PHASE OFFSET

The NCO phase offset register at Address 0x122 and Address 0x123 adds a programmable offset to the phase accumulator of the NCO. This 16-bit register is interpreted as a 16-bit unsigned integer. A 0x00 in this register corresponds to no offset, and a 0xFFFF corresponds to an offset of 359.995° . Each bit represents a phase change of 0.005° . This register allows multiple NCOs to be synchronized to produce outputs with predictable phase differences. Use the following equation to calculate the NCO phase offset value:

$$NCO_PHASE = 2^{16} \times PHASE/360$$

where:

NCO_PHASE is a decimal number equal to the 16-bit binary number to be programmed at Register 0x122 and Register 0x123. $PHASE$ is the desired NCO phase in degrees.

NCO AMPLITUDE AND PHASE DITHER

The NCO block contains amplitude and phase dither to improve the spurious performance. Amplitude dither improves performance by randomizing the amplitude quantization errors within the angular-to-Cartesian conversion of the NCO. This option reduces spurs at the expense of a slightly raised noise floor. With amplitude dither enabled, the NCO has an SNR of >93 dB and an SFDR of >115 dB. With amplitude dither disabled, the SNR is increased to >96 dB at the cost of SFDR performance, which is reduced to 100 dB. The NCO amplitude dither is recommended and is enabled by setting Bit 1 of Register 0x11D.

DECIMATING HALF-BAND FILTER AND FIR FILTER

The goal of the AD6655 half-band digital filter is to allow the sample rate to be reduced by a factor of 2 while rejecting aliases that fall into the band of interest. This filter is designed to operate as either a low-pass or a high-pass filter and to provide >100 dB of alias protection for 11% of the input rate of the structure. Used in conjunction with the NCO and the FIR filter, the half-band filter can provide an effective band-pass. For an ADC sample rate of 150 MSPS, this provides a maximum usable bandwidth of 33 MHz.

HALF-BAND FILTER COEFFICIENTS

The 19-tap, symmetrical, fixed-coefficient half-band filter has low power consumption due to its polyphase implementation. Table 19 lists the coefficients of the half-band filter. The normalized coefficients used in the implementation and the decimal equivalent value of the coefficients are also listed. Coefficients not listed in Table 19 are 0s.

Table 19. Fixed Coefficients for Half-Band Filter

Coefficient Number	Normalized Coefficient	Decimal Coefficient (20-Bit)
C0, C18	0.0008049	844
C2, C16	-0.0059023	-6189
C4, C14	0.0239182	25080
C6, C12	-0.0755024	-79170
C8, C10	0.3066864	321584
C9	0.5	524287

HALF-BAND FILTER FEATURES

In the AD6655, the half-band filter cannot be disabled. The filter can be set for a low-pass or high-pass response. For a high-pass filter, Bit 1 of Register 0x103 should be set; for a low-pass response, this bit should be cleared. The low-pass response of the filter with respect to the normalized output rate is shown in Figure 72, and the high-pass response is shown in Figure 73.

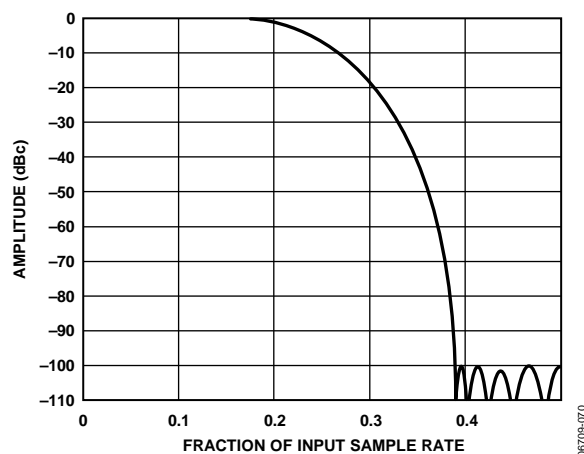

Figure 72. Half-Band Filter Low-Pass Response

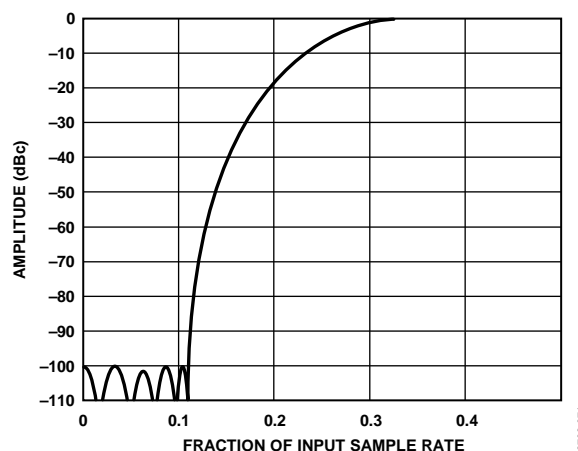

Figure 73. Half-Band Filter High-Pass Response

The half-band filter has a ripple of 0.000182 dB and a rejection of 100 dB. For an alias rejection of 100 dB, the alias protected bandwidth is 11% of the input sample rate. If both the I and the Q paths are used, a complex bandwidth of 22% of the input rate is available.

In the event of even Nyquist zone sampling, the half-band filter can be configured to provide a spectral reversal. Setting Bit 2 high in Address 0x103 enables the spectral reversal feature.

The half-band decimation phase can be selected such that the half-band filter starts on the first or second sample following synchronization. This shifts the output from the half-band between the two input sample clocks. The decimation phase can be set to 0 or 1, using Bit 3 of Register 0x103.

FIXED-COEFFICIENT FIR FILTER

Following the half-band filters is a 66-tap, fixed-coefficient FIR filter. This filter is useful in providing extra alias protection for the decimating half-band filter. It is a simple sum-of-products FIR filter with 66 filter taps and 21-bit fixed coefficients. Note that this filter does not decimate. The normalized coefficients used in the implementation and the decimal equivalent value of the coefficients are listed in Table 20.

The user can either select or bypass this filter, but the FIR filter can be enabled only when the half-band filter is enabled. Writing Logic 0 to the enable FIR filter bit (Bit 0) in Register 0x102 bypasses this fixed-coefficient filter. The filter is necessary when using the final NCO with a real output; bypassing it when using other configurations results in power savings.

Table 20. FIR Filter Coefficients

Coefficient Number	Normalized Coefficient	Decimal Coefficient (21-Bit)
C0, C65	0.0001826	383
C1, C64	0.0006824	1431
C2, C63	0.0009298	1950
C3, C62	0.0000458	96
C4, C61	-0.0012689	-2661
C5, C60	-0.0008345	-1750
C6, C59	0.0011806	2476
C7, C58	0.0011387	2388
C8, C57	-0.0018439	-3867
C9, C56	-0.0024557	-5150
C10, C55	0.0018063	3788
C11, C54	0.0035825	7513
C12, C53	-0.0021510	-4511
C13, C52	-0.0056810	-11914
C14, C51	0.0017405	3650
C15, C50	0.0078602	16484
C16, C49	-0.0013437	-2818
C17, C48	-0.0110626	-23200
C18, C47	-0.0000229	-48
C19, C46	0.0146618	30748
C20, C45	0.0018959	3976
C21, C44	-0.0195594	-41019
C22, C43	-0.0053153	-11147
C23, C42	0.0255623	53608
C24, C41	0.0104036	21818
C25, C40	-0.0341468	-71611
C26, C39	-0.0192165	-40300
C27, C38	0.0471258	98830
C28, C37	0.0354118	74264
C29, C36	-0.0728111	-152696
C30, C35	-0.0768890	-161248
C31, C34	0.1607208	337056
C32, C33	0.4396725	922060

SYNCHRONIZATION

The AD6655 half-band filters within a single part or across multiple parts can be synchronized using the external SYNC input. Bit 5 and Bit 6 of Register 0x100 allow the half-bands to be resynchronized on every SYNC signal or only on the first SYNC signal after the register is written. A valid SYNC causes the half-band filter to restart at the programmed decimation phase value.

COMBINED FILTER PERFORMANCE

The combined response of the half-band filter and the FIR filter is shown in Figure 74. The act of bandlimiting the ADC data with the half-band filter ideally provides a 3 dB improvement in the SNR at the expense of the sample rate and available bandwidth of the output data. As a consequence of finite math, additional quantization noise is added to the system due to truncation in the NCO and half-band. As a consequence of the digital filter rejection of out-of-band noise (assuming no quantization in the filters and with a white noise floor from the ADC), there should be a 3.16 dB improvement in the ADC SNR. However, the added quantization lessens improvement to about 2.66 dB.

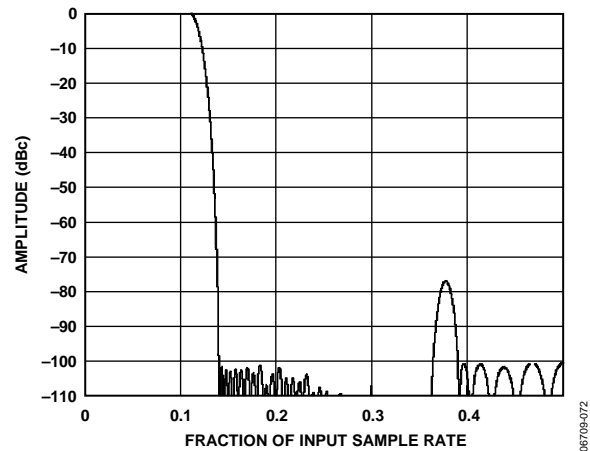

Figure 74. Half-Band Filter and FIR Filter Composite Response

FINAL NCO

The output of the 32-bit fine tuning NCO is complex and typically centered in frequency around dc. This complex output is carried through the stages of the half-band and FIR filters to provide proper antialiasing filtering. The final NCO provides a means to move this complex output signal away from dc so that a real output can be provided from the AD6655. The final NCO, if enabled, translates the output from dc to a frequency equal to the ADC sampling frequency divided by 8 ($f_{ADC}/8$). This provides the user a decimated output signal centered at $f_{ADC}/8$ in frequency. Optionally, this final NCO can be bypassed, and the dc-centered I and Q values can be output in an interleaved fashion.

ADC OVERRANGE AND GAIN CONTROL

In receiver applications, it is desirable to have a mechanism to reliably determine when the converter is about to be clipped. The standard overflow indicator provides after-the-fact information on the state of the analog input that is of limited usefulness. Therefore, it is helpful to have a programmable threshold below full scale that allows time to reduce the gain before the clip actually occurs. In addition, because input signals can have significant slew rates, latency of this function is of major concern. Highly pipelined converters can have significant latency. A good compromise is to use the output bits from the first stage of the ADC for this function. Latency for these output bits is very low, and overall resolution is not highly significant. Peak input signals are typically between full scale and 6 dB to 10 dB below full scale. A 3-bit or 4-bit output provides adequate range and resolution for this function.

Using the SPI port, the user can provide a threshold above which an overrange output is active. As long as the signal is below that threshold, the output should remain low. The fast detect outputs can also be programmed via the SPI port so that one of the pins functions as a traditional overrange pin for customers who currently use this feature. In this mode, all 14 bits of the converter are examined in the traditional manner, and the output is high for the condition normally defined as overflow. In either mode, the magnitude of the data is considered in the calculation of the condition (but the sign of the data is not considered). The threshold detection responds identically to positive and negative signals outside the desired range (magnitude).

FAST DETECT OVERVIEW

The AD6655 contains circuitry to facilitate fast overrange detection, allowing very flexible external gain control implementations. Each ADC has four fast detect (FD) output pins that are used to output information about the current state of the ADC input level. The function of these pins is programmable via the fast detect mode select bits and the fast detect enable bit in Register 0x104, allowing range information to be output from several points in the internal data path. These output pins can also be set up to indicate the presence of overrange or underrange conditions, according to programmable threshold levels. Table 21 shows the six configurations available for the fast detect pins.

Table 21. Fast Detect Mode Select Bits Settings

Fast Detect Mode Select bits (Register 0x104[3:1])	Information Presented on Fast Detect (FD) Pins of Each ADC ^{1,2}			
	FD[3]	FD[2]	FD[1]	FD[0]
000	ADC fast magnitude (see Table 22)			
001	ADC fast magnitude (see Table 23)			OR
010	ADC fast magnitude (see Table 24)		OR	F_LT
011	ADC fast magnitude (see Table 24)		C_UT	F_LT
100	OR	C_UT	F_UT	F_LT
101	OR	F_UT	IG	DG

¹ The fast detect pins are FD0A/FD0B to FD3A/FD3B for the CMOS mode configuration and FD0+/FD0– to FD3+/FD3– for the LVDS mode configuration.

² See the ADC Overrange (OR) and Gain Switching sections for more information about OR, C_UT, F_UT, F_LT, IG, and DG.

ADC FAST MAGNITUDE

When the fast detect output pins are configured to output the ADC fast magnitude (that is, when the fast detect mode select bits are set to 0b000), the information presented is the ADC level from an early converter stage with a latency of only two clock cycles in CMOS output modes. In LVDS output mode, the fast detect bits have a latency of six cycles in all fast detect modes. Using the fast detect output pins in this configuration provides the earliest possible level indication information. Because this information is provided early in the datapath, there is significant uncertainty in the level indicated. The nominal levels, along with the uncertainty indicated by the ADC fast magnitude, are shown in Table 22. Because the DCO is at one-half the sample rate, the user can obtain all the fast detect information by sampling the fast detect outputs on both the rising and falling edge of DCO (see Figure 2 for timing information).

Table 22. ADC Fast Magnitude Nominal Levels with Fast Detect Mode Select Bits = 000

ADC Fast Magitude on FD[3:0] Pins	Nominal Input Magnitude Below FS (dB)	Nominal Input Magnitude Uncertainty (dB)
0000	<–24	Minimum to –18.07
0001	–24 to –14.5	–30.14 to –12.04
0010	–14.5 to –10	–18.07 to –8.52
0011	–10 to –7	–12.04 to –6.02
0100	–7 to –5	–8.52 to –4.08
0101	–5 to –3.25	–6.02 to –2.5
0110	–3.25 to –1.8	–4.08 to –1.16
0111	–1.8 to –0.56	–2.5 to FS
1000	–0.56 to 0	–1.16 to 0

AD6655

When the fast detect mode select bits are set to 0b001, 0b010, or 0b011, a subset of the fast detect output pins are available. In these modes, the fast detect output pins have a latency of six clock cycles, and the greater of the two input samples is output at the DCO rate. Table 23 shows the corresponding ADC input levels when the fast detect mode select bits are set to 0b001 (that is, when the ADC fast magnitude is presented on the FD[3:1] pins).

Table 23. ADC Fast Magnitude Nominal Levels with Fast Detect Mode Select Bits = 001

ADC Fast Magnitude on FD[2:0] Pins	Nominal Input Magnitude Below FS (dB)	Nominal Input Magnitude Uncertainty (dB)
000	<-24	Minimum to -18.07
001	-24 to -14.5	-30.14 to -12.04
010	-14.5 to -10	-18.07 to -8.52
011	-10 to -7	-12.04 to -6.02
100	-7 to -5	-8.52 to -4.08
101	-5 to -3.25	-6.02 to -2.5
110	-3.25 to -1.8	-4.08 to -1.16
111	-1.8 to 0	-2.5 to 0

When the fast detect mode select bits are set to 0b010 or 0b011 (that is, when ADC fast magnitude is presented on the FD[2:1] pins), the LSB is not provided. The input ranges for this mode are shown in Table 24.

Table 24. ADC Fast Magnitude Nominal Levels with Fast Detect Mode Select Bits = 010 or 011

ADC Fast Magnitude on FD[2:1] Pins	Nominal Input Magnitude Below FS (dB)	Nominal Input Magnitude Uncertainty (dB)
00	<-14.5	Minimum to -12.04
01	-14.5 to -7	-18.07 to -6.02
10	-7 to -3.25	-8.52 to -2.5
11	-3.25 to 0	-4.08 to 0

ADC OVERRANGE (OR)

The ADC overrange indicator is asserted when an overrange is detected on the input of the ADC. The overrange condition is determined at the output of the ADC pipeline and, therefore, is subject to a latency of 12 ADC clock cycles. An overrange at the input is indicated by this bit 12 clock cycles after it occurs.

GAIN SWITCHING

The AD6655 includes circuitry that is useful in applications either where large dynamic ranges exist or where gain ranging converters are employed. This circuitry allows digital thresholds to be set such that an upper threshold and a lower threshold can be programmed. Fast detect mode select bits = 010 through fast detect mode select bits = 101 support various combinations of the gain switching options.

One such use is to detect when an ADC is about to reach full scale with a particular input condition. The result is to provide an indicator that can be used to quickly insert an attenuator that prevents ADC overdrive.

Coarse Upper Threshold (C_UT)

The coarse upper threshold indicator is asserted if the ADC fast magnitude input level is greater than the level programmed in the coarse upper threshold register (Address 0x105[2:0]). This value is compared with the ADC Fast Magnitude Bits[2:0]. The coarse upper threshold output is output two clock cycles after the level is exceeded at the input and, therefore, provides a fast indication of the input signal level. The coarse upper threshold levels are shown in Table 25. This indicator remains asserted for a minimum of two ADC clock cycles or until the signal drops below the threshold level.

Table 25. Coarse Upper Threshold Levels

Coarse Upper Threshold Register[2:0]	C_UT Is Active When Signal Magnitude Below FS Is Greater Than (dB)
000	<-24
001	-24
010	-14.5
011	-10
100	-7
101	-5
110	-3.25
111	-1.8

Fine Upper Threshold (F_UT)

The fine upper threshold indicator is asserted if the input magnitude exceeds the value programmed in the fine upper threshold register located in Register 0x106 and Register 0x107. The 13-bit threshold register is compared with the signal magnitude at the output of the ADC. This comparison is subject to the ADC clock latency but is accurate in terms of converter resolution. The fine upper threshold magnitude is defined by the following equation:

$$dBFS = 20 \log(\text{Threshold Magnitude}/2^{13})$$

Fine Lower Threshold (F_LT)

The fine lower threshold indicator is asserted if the input magnitude is less than the value programmed in the fine lower threshold register located at Register 0x108 and Register 0x109. The fine lower threshold register is a 13-bit register that is compared with the signal magnitude at the output of the ADC. This comparison is subject to ADC clock latency but is accurate in terms of converter resolution. The fine lower threshold magnitude is defined by the following equation:

$$dBFS = 20 \log(\text{Threshold Magnitude}/2^{13})$$

The operation of the fine upper threshold and fine lower threshold indicators is shown in Figure 75.

Increment Gain (IG) and Decrement Gain (DG)

The increment gain and decrement gain indicators are intended to be used together to provide information to enable external gain control. The decrement gain indicator works in conjunction with the coarse upper threshold bits, asserting when the input magnitude is greater than the 3-bit value in the coarse upper threshold register (Address 0x105). The increment gain indicator, similarly, corresponds to the fine lower threshold bits except that it is asserted only if the input magnitude is less than the value programmed in the fine lower threshold register after the dwell time elapses. The dwell time is set by the 16-bit dwell time value located at Address 0x10A and Address 0x10B and is set in units of ADC input clock cycles ranging from 1 to 65,535. The fine lower threshold register is a 13-bit register that is compared

with the magnitude at the output of the ADC. This comparison is subject to the ADC clock latency but allows a finer, more accurate comparison. The fine upper threshold magnitude is defined by the following equation:

$$dBFS = 20 \log(\text{Threshold Magnitude}/2^{13})$$

The decrement gain output works from the ADC fast detect output pins, providing a fast indication of potential overrange conditions. The increment gain uses the comparison at the output of the ADC, requiring the input magnitude to remain below an accurate, programmable level for a predefined period before signaling external circuitry to increase the gain.

The operation of the increment gain output and decrement gain output is shown graphically in Figure 75.

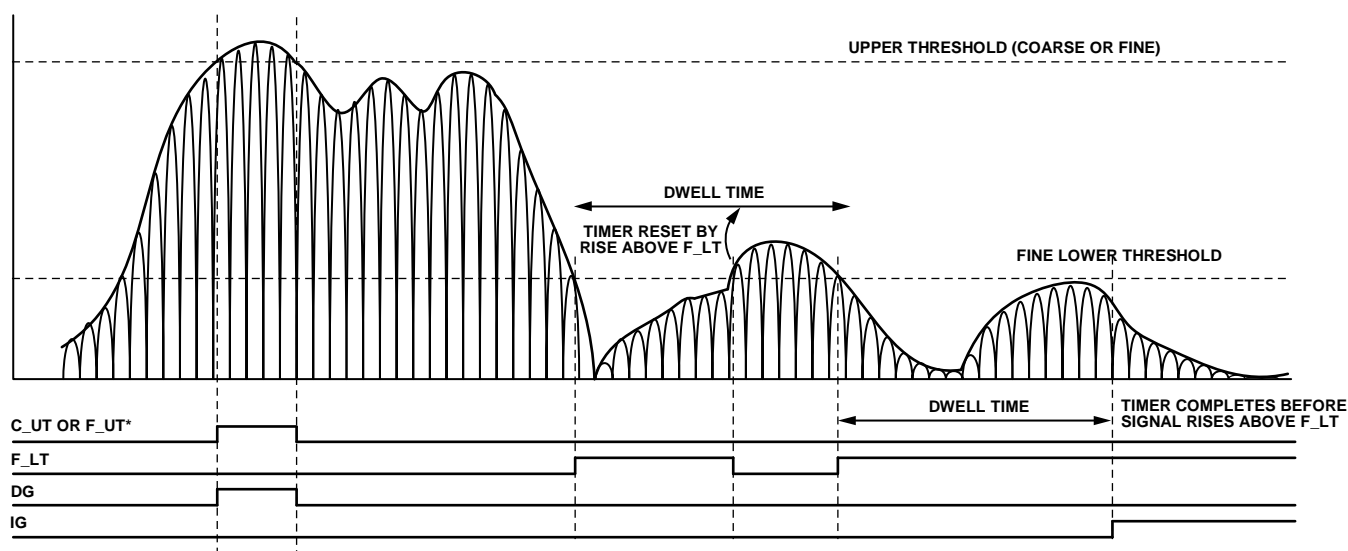

*C_UT AND F_UT DIFFER ONLY IN ACCURACY AND LATENCY.

NOTE: OUTPUTS FOLLOW THE INSTANTEOUS SIGNAL LEVEL AND NOT THE ENVELOPE BUT ARE GUARANTEED ACTIVE FOR A MINIMUM OF 2 ADC CLOCK CYCLES.

Figure 75. Threshold Settings for C_UT, F_UT, F_LT, DG, and IG

06709-073

SIGNAL MONITOR

The signal monitor block provides additional information about the signal being digitized by the ADC. The signal monitor computes the rms input magnitude, the peak magnitude, and/or the number of samples by which the magnitude exceeds a particular threshold. Together, these functions can be used to gain insight into the signal characteristics and to estimate the peak/average ratio or even the shape of the complementary cumulative distribution function (CCDF) curve of the input signal. This information can be used to drive an AGC loop to optimize the range of the ADC in the presence of real-world signals.

The signal monitor result values can be obtained from the part by reading back internal registers at Address 0x116 to Address 0x11B, using the SPI port or the signal monitor SPORT output. The output contents of the SPI-accessible signal monitor registers are set via the two signal monitor mode bits of the signal monitor control register (Address 0x112). Both ADC channels must be configured for the same signal monitor mode. Separate SPI-accessible, 20-bit signal monitor result (SMR) registers are provided for each ADC channel. Any combination of the signal monitor functions can also be output to the user via the serial SPORT interface. These outputs are enabled using the peak detector output enable, the rms magnitude output enable, and the threshold crossing output enable bits in the signal monitor SPORT control register (Address 0x1111).

For each signal monitor measurement, a programmable signal monitor period register (SMPR) controls the duration of the measurement. This time period is programmed as the number of input clock cycles in a 24-bit signal monitor period register located at Address 0x113, Address 0x114, and Address 0x115. This register can be programmed with a period from 128 samples to 16.78 (2^{24}) million samples.

Because the dc offset of the ADC can be significantly larger than the signal of interest (affecting the results from the signal monitor), a dc correction circuit is included as part of the signal monitor block to null the dc offset before measuring the power.

PEAK DETECTOR MODE

The magnitude of the input port signal is monitored over a programmable time period (determined by SMPR) to give the peak value detected. This function is enabled by programming a Logic 1 in the signal monitor mode bits of the signal monitor control register or by setting the peak detector output enable bit in the signal monitor SPORT control register. The 24-bit SMPR must be programmed before activating this mode.

After enabling this mode, the value in the SMPR is loaded into a monitor period timer, and the countdown is started. The magnitude of the input signal is compared with the value in the internal peak level holding register (not accessible to the user), and the greater of the two is updated as the current peak level. The initial value of the peak level holding register is set to the

current ADC input signal magnitude. This comparison continues until the monitor period timer reaches a count of 1.

When the monitor period timer reaches a count of 1, the 13-bit peak level value is transferred to the signal monitor holding register (not accessible to the user), which can be read through the SPI port or output through the SPORT serial interface. The monitor period timer is reloaded with the value in the SMPR, and the countdown is restarted. In addition, the magnitude of the first input sample is updated in the peak level holding register, and the comparison and update procedure, as explained previously, continues.

Figure 76 is a block diagram of the peak detector logic. The SMR register contains the absolute magnitude of the peak detected by the peak detector logic.

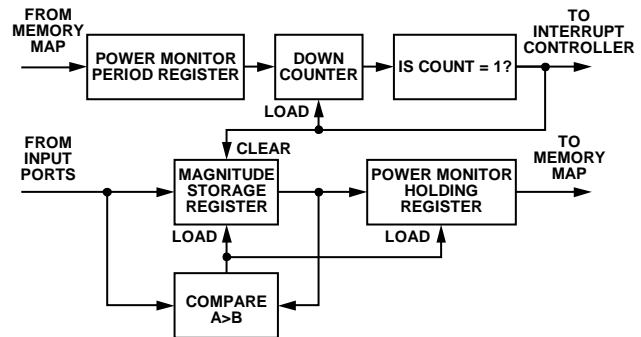

Figure 76. ADC Input Peak Detector Block Diagram

RMS/MS MAGNITUDE MODE

In this mode, the root-mean-square (rms) or mean-square (ms) magnitude of the input port signal is integrated (by adding an accumulator) over a programmable time period (determined by SMPR) to give the rms or ms magnitude of the input signal. This mode is set by programming Logic 0 in the signal monitor mode bits of the signal monitor control register or by setting the rms magnitude output enable bit in the signal monitor SPORT control register. The 24-bit SMPR, representing the period over which integration is performed, must be programmed before activating this mode.

After enabling the rms/ms magnitude mode, the value in the SMPR is loaded into a monitor period timer, and the countdown is started immediately. Each input sample is converted to floating-point format and squared. It is then converted to 11-bit, fixed-point format and added to the contents of the 24-bit accumulator. The integration continues until the monitor period timer reaches a count of 1.

When the monitor period timer reaches a count of 1, the square root of the value in the accumulator is taken and transferred (after some formatting) to the signal monitor holding register, which can be read through the SPI port or output through the SPORT serial port. The monitor period timer is reloaded with the value in the SMPR, and the countdown is restarted.

In addition, the first input sample signal power is updated in the accumulator, and the accumulation continues with the subsequent input samples. Figure 77 illustrates the rms magnitude monitoring logic.

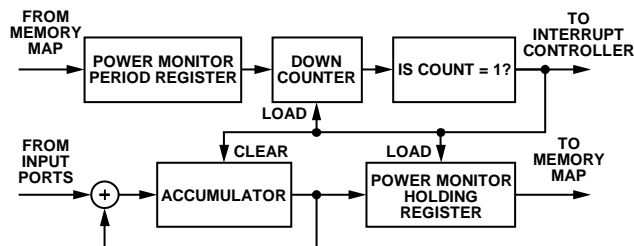

Figure 77. ADC Input RMS Magnitude Monitoring Block Diagram

For rms magnitude mode, the value in the signal monitor result (SMR) register is a 20-bit fixed-point number. The following equation can be used to determine the rms magnitude in dBFS from the MAG value in the register. Note that if the signal monitor period (SMP) is a power of 2, the second term in the equation becomes 0.

$$RMS\ Magnitude = 20 \log \left(\frac{MAG}{2^{20}} \right) - 10 \log \left[\frac{SMP}{2^{ceil[\log_2(SMP)]}} \right]$$

For ms magnitude mode, the value in the SMR is a 20-bit fixed-point number. The following equation can be used to determine the ms magnitude in dBFS from the MAG value in the register. Note that if the SMP is a power of 2, the second term in the equation becomes 0.

$$MS\ Magnitude = 10 \log \left(\frac{MAG}{2^{20}} \right) - 10 \log \left[\frac{SMP}{2^{ceil[\log_2(SMP)]}} \right]$$

THRESHOLD CROSSING MODE

In the threshold crossing mode of operation, the magnitude of the input port signal is monitored over a programmable time period (given by SMPR) to count the number of times it crosses a certain programmable threshold value. This mode is set by programming Logic 1x (where x is a don't care bit) in the signal monitor mode bits of the signal monitor control register or by setting the threshold crossing output enable bit in the signal monitor SPORT control register. Before activating this mode, the user needs to program the 24-bit SMPR and the 13-bit upper threshold register for each individual input port. The same upper threshold register is used for both signal monitoring and gain control (see the ADC Overrange and Gain Control section).

After entering this mode, the value in the SMPR is loaded into a monitor period timer, and the countdown is started. The magnitude of the input signal is compared with the upper threshold register (programmed previously) on each input clock cycle. If the input signal has a magnitude greater than the upper threshold register, the internal count register is incremented by 1. The initial value of the internal count register is set to 0. This comparison and incrementing of the internal count register continues until the monitor period timer reaches a count of 1.

When the monitor period timer reaches a count of 1, the value in the internal count register is transferred to the signal monitor holding register, which can be read through the SPI port or output through the SPORT serial port.

The monitor period timer is reloaded with the value in the SMPR register, and the countdown is restarted. The internal count register is also cleared to a value of 0. Figure 78 illustrates the threshold crossing logic. The value in the SMR register is the number of samples that have a magnitude greater than the threshold register.

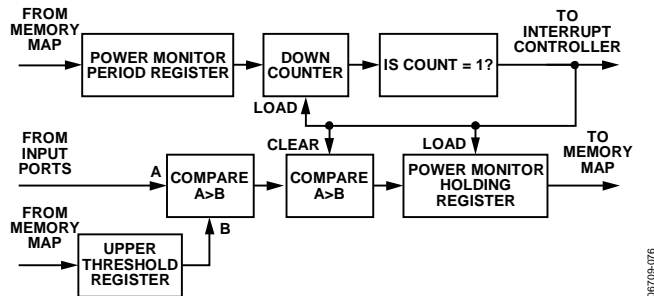

Figure 78. ADC Input Threshold Crossing Block Diagram

ADDITIONAL CONTROL BITS

For additional flexibility in the signal monitoring process, two control bits are provided in the signal monitor control register. They are the signal monitor enable bit and the complex power calculation mode enable bit.

Signal Monitor Enable Bit

The signal monitor enable bit, located in Bit 0 of Register 0x112, enables operation of the signal monitor block. If the signal monitor function is not needed in a particular application, this bit should be cleared to conserve power.

Complex Power Calculation Mode Enable Bit

When this bit is set, the part assumes that Channel A is digitizing the I data and Channel B is digitizing the Q data for a complex input signal (or vice versa). In this mode, the power reported is equal to

$$\sqrt{I^2 + Q^2}$$

This result is presented in the Signal Monitor DC Value Channel A register if the signal monitor mode bits are set to 00. The Signal Monitor DC Value Channel B register continues to compute the Channel B value.

DC CORRECTION

Because the dc offset of the ADC may be significantly larger than the signal being measured, a dc correction circuit is included to null the dc offset before measuring the power. The dc correction circuit can also be switched into the main signal path, but this may not be appropriate if the ADC is digitizing a time-varying signal with significant dc content, such as GSM.

DC Correction Bandwidth

The dc correction circuit is a high-pass filter with a programmable bandwidth (ranging between 0.15 Hz and 1.2 kHz at 125 MSPS). The bandwidth is controlled by writing the 4-bit dc correction control register located at Register 0x10C, Bits[5:2]. The following equation can be used to compute the bandwidth value for the dc correction circuit:

$$DC_Corr_BW = 2^{-k-14} \times \frac{f_{CLK}}{2 \times \pi}$$

where:

k is the 4-bit value programmed in Bits[5:2] of Register 0x10C (values between 0 and 13 are valid for k ; programming 14 or 15 provides the same result as programming 13).

f_{CLK} is the AD6655 ADC sample rate in hertz (Hz).

DC Correction Readback

The current dc correction value can be read back in Register 0x10D and Register 0x10E for Channel A and Register 0x10F and Register 0x110 for Channel B. The dc correction value is a 14-bit value that can span the entire input range of the ADC.

DC Correction Freeze

Setting Bit 6 of Register 0x10C freezes the DC correction at its current state and continues to use the last updated value as the dc correction value. Clearing this bit restarts dc correction and adds the currently calculated value to the data.

DC Correction Enable Bits

Setting Bit 0 of Register 0x10C enables dc correction for use in the signal monitor calculations. The calculated dc correction value can be added to the output data signal path by setting Bit 1 of Register 0x10C.

SIGNAL MONITOR SPORT OUTPUT

The SPORT is a serial interface with three output pins: the SMI SCLK (SPORT clock), SMI SDFS (SPORT frame sync), and SMI SDO (SPORT data output). The SPORT is the master and drives all three SPORT output pins on the chip.

SMI SCLK

The data and frame sync are driven on the positive edge of the SMI SCLK. The SMI SCLK has three possible baud rates: 1/2, 1/4, or 1/8 the ADC clock rate, based on the SPORT controls. The SMI SCLK can also be gated off when not sending any data, based on the SPORT SMI SCLK sleep bit. Using this bit to disable the SMI SCLK when it is not needed can reduce any coupling errors back into the signal path, if these prove to be a problem in the system. Doing so, however, has the disadvantage of spreading the frequency content of the clock. If desired the SMI SCLK can be left running to ease frequency planning.

SMI SDFS

The SMI SDFS is the serial data frame sync, and it defines the start of a frame. One SPORT frame includes data from both datapaths. The data from Datapath A is sent just after the frame sync, followed by data from Datapath B.

SMI SDO

The SMI SDO is the serial data output of the block. The data is sent MSB first on the next positive edge after the SMI SDFS. Each data output block includes one or more of rms magnitude, peak level, and threshold crossing values from each datapath in the stated order. If enabled, the data is sent, rms first, followed by peak and threshold, as shown in Figure 79.

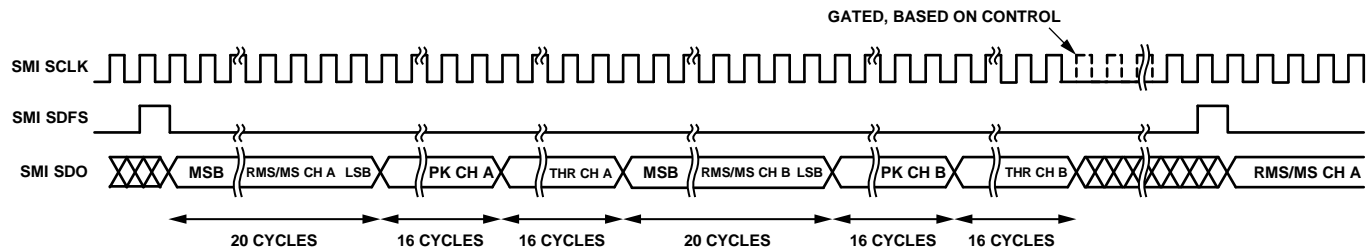

Figure 79. Signal Monitor SPORT Output Timing (RMS, Peak, and Threshold Enabled)

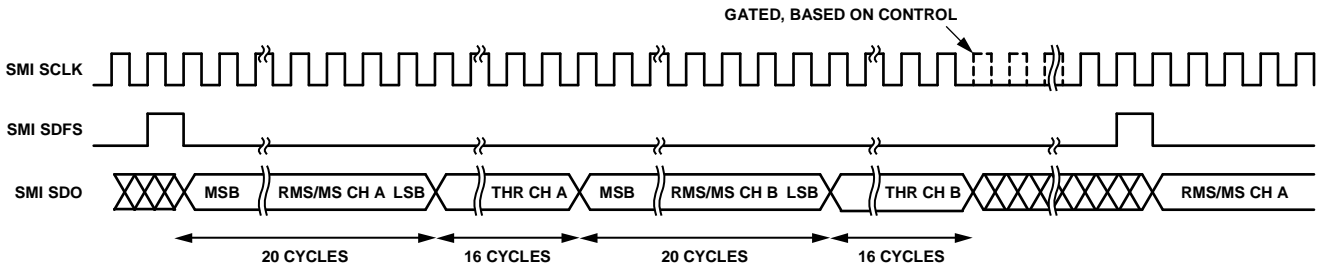

Figure 80. Signal Monitor SPORT Output Timing (RMS and Threshold Enabled)

CHANNEL/CHIP SYNCHRONIZATION

The AD6655 has a SYNC input that allows the user flexible synchronization options for synchronizing the internal blocks. The sync feature is useful for guaranteeing synchronized operation across multiple ADCs. The input clock divider, NCO, half-band filters, and signal monitor block can be synchronized using the SYNC input. Each of these blocks, except for the signal monitor, can be enabled to synchronize on a single occurrence of the SYNC signal or on every occurrence.

The SYNC input is internally synchronized to the sample clock. However, to ensure that there is no timing uncertainty between multiple parts, the SYNC input signal should be synchronized to the input clock signal. The SYNC input should be driven using a single-ended CMOS type signal.

SERIAL PORT INTERFACE (SPI)

The AD6655 serial port interface (SPI) allows the user to configure the converter for specific functions or operations through a structured register space provided inside the ADC. The SPI gives the user added flexibility and customization, depending on the application. Addresses are accessed via the serial port and can be written to or read from via the port. Memory is organized into bytes that can be further divided into fields. These fields are documented in the Memory Map section. For detailed operational information, see Application Note AN-877, *Interfacing to High Speed ADCs via SPI*.

CONFIGURATION USING THE SPI

Three pins define the SPI of this ADC: the SCLK/DFS pin, the SDIO/DCS pin, and the CSB pin (see Table 26). The SCLK/DFS (serial clock) pin is used to synchronize the read and write data presented from/to the ADC. The SDIO/DCS (serial data input/output) pin is a dual-purpose pin that allows data to be sent and read from the internal ADC memory map registers. The CSB (chip select bar) pin is an active-low control that enables or disables the read and write cycles.

Table 26. Serial Port Interface Pins

Pin	Function
SCLK	Serial Clock. The serial shift clock input, which is used to synchronize serial interface reads and writes.
SDIO	Serial Data Input/Output. A dual-purpose pin that typically serves as an input or an output, depending on the instruction being sent and the relative position in the timing frame.
CSB	Chip Select Bar. An active-low control that gates the read and write cycles.

The falling edge of the CSB, in conjunction with the rising edge of the SCLK, determines the start of the framing. An example of the serial timing and its definitions can be found in Figure 81 and Table 9.

Other modes involving the CSB are available. The CSB can be held low indefinitely, which permanently enables the device; this is called streaming. The CSB can stall high between bytes to allow for additional external timing. When CSB is tied high, SPI functions are placed in a high impedance mode. This mode turns on any SPI pin secondary functions.

During an instruction phase, a 16-bit instruction is transmitted. Data follows the instruction phase, and its length is determined by the W0 bit and the W1 bit.

All data is composed of 8-bit words. The first bit of each individual byte of serial data indicates whether a read command or a write command is issued. This allows the serial data input/output (SDIO) pin to change direction from an input to an output.

In addition to word length, the instruction phase determines whether the serial frame is a read or write operation, allowing the serial port to be used both to program the chip and to read the contents of the on-chip memory. If the instruction is a readback operation, performing a readback causes the serial data input/output (SDIO) pin to change direction from an input to an output at the appropriate point in the serial frame.

Data can be sent in MSB-first mode or in LSB-first mode. MSB first is the default on power-up and can be changed via the SPI port configuration register. For more information about this and other features, see Application Note AN-877, *Interfacing to High Speed ADCs via SPI* at www.analog.com.

HARDWARE INTERFACE

The pins described in Table 26 comprise the physical interface between the user programming device and the serial port of the AD6655. The SCLK pin and the CSB pin function as inputs when using the SPI interface. The SDIO pin is bidirectional, functioning as an input during write phases and as an output during readback.

The SPI interface is flexible enough to be controlled by either FPGAs or microcontrollers. One method for SPI configuration is described in detail in Application Note AN-812, *Microcontroller-Based Serial Port Interface (SPI) Boot Circuit*.

The SPI port should not be active during periods when the full dynamic performance of the converter is required. Because the SCLK signal, the CSB signal, and the SDIO signal are typically asynchronous to the ADC clock, noise from these signals can degrade converter performance. If the on-board SPI bus is used for other devices, it may be necessary to provide buffers between this bus and the AD6655 to prevent these signals from transitioning at the converter inputs during critical sampling periods.

Some pins serve a dual function when the SPI interface is not being used. When the pins are strapped to AVDD or ground during device power-on, they are associated with a specific function. The Digital Outputs section describes the strappable functions supported on the AD6655.

CONFIGURATION WITHOUT THE SPI

In applications that do not interface to the SPI control registers, the SDIO/DCS pin, the SCLK/DFS pin, the SMI SDO/OEB pin, and the SMI SCLK/PDWN pin serve as standalone CMOS-compatible control pins. When the device is powered up, it is assumed that the user intends to use the pins as static control lines for the duty cycle stabilizer, output data format, output enable, and power-down feature control. In this mode, the CSB chip select should be connected to AVDD, which disables the serial port interface.

Table 27. Mode Selection

Pin	External Voltage	Configuration
SDIO/DCS	AVDD (default)	Duty cycle stabilizer enabled
	AGND	Duty cycle stabilizer disabled
SCLK/DFS	AVDD	Twos complement enabled
	AGND (default)	Offset binary enabled
SMI SDO/OEB	AVDD	Outputs in high impedance
	AGND (default)	Outputs enabled
SMI SCLK/PDWN	AVDD	Chip in power-down or standby
	AGND (default)	Normal operation

SPI ACCESSIBLE FEATURES

Table 28 provides a brief description of the general features that are accessible via the SPI. These features are described in detail in Application Note AN-877, *Interfacing to High Speed ADCs via SPI* (see www.analog.com). The AD6655 part-specific features are described in the Memory Map Register Description section.

Table 28. Features Accessible Using the SPI

Feature Name	Description
Mode	Allows the user to set either power-down mode or standby mode
Clock	Allows the user to access the DCS via the SPI
Offset	Allows the user to digitally adjust the converter offset
Test I/O	Allows the user to set test modes to have known data on output bits
Output Mode	Allows the user to set up outputs
Output Phase	Allows the user to set the output clock polarity
Output Delay	Allows the user to vary the DCO delay
VREF	Allows the user to set the reference voltage

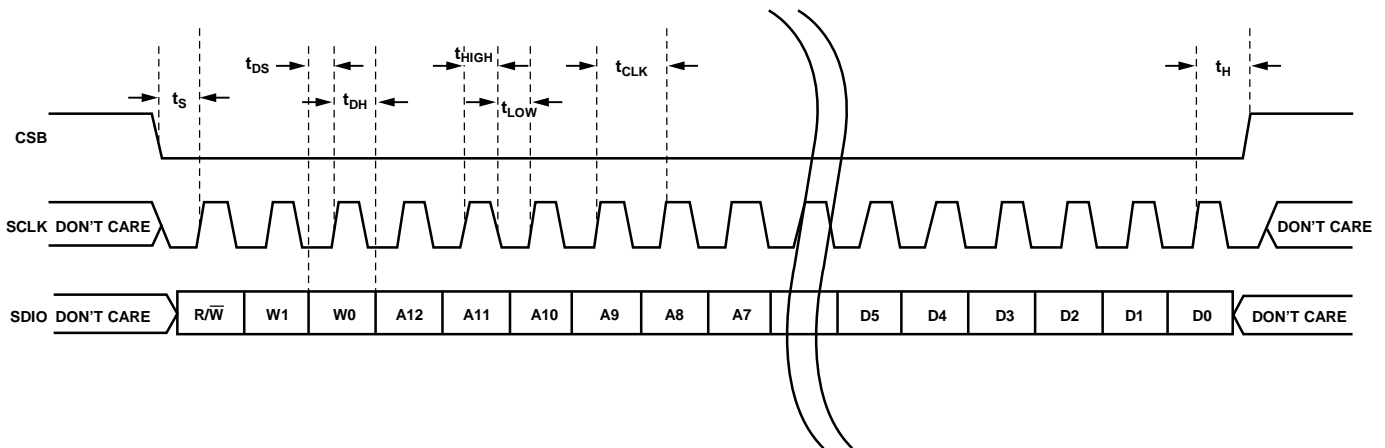

Figure 81. Serial Port Interface Timing Diagram

06718-079

MEMORY MAP

READING THE MEMORY MAP REGISTER TABLE

Each row in the memory map register table has eight bit locations. The memory map is roughly divided into four sections: the chip configuration registers (Address 0x00 to Address 0x02); the channel index and transfer registers (Address 0x05 and Address 0xFF); the ADC functions registers, including setup, control, and test (Address 0x08 to Address 0x18); and the digital feature control registers (Address 0x100 to Address 0x123).

The memory map register table (see Table 29) documents the default hexadecimal value for each hexadecimal address shown. The column with the heading Bit 7 (MSB) is the start of the default hexadecimal value given. For example, Address 0x18, the VREF select register, has a hexadecimal default value of 0xC0. This means that Bit 7 = 1, Bit 6 = 1, and the remaining bits are 0s. This setting is the default reference selection setting. The default value uses a 2.0 V p-p reference. For more information on this function and others, see Application Note AN-877, *Interfacing to High Speed ADCs via SPI*. This document details the functions controlled by Register 0x00 to Register 0xFF. The remaining registers, from Register 0x100 to Register 0x123, are documented in the Memory Map Register Description section.

Open Locations

All address and bit locations that are not included in Table 29 are not currently supported for this device. Unused bits of a valid address location should be written with 0s. Writing to these locations is required only when part of an address location is open (for example, Address 0x18). If the entire address location is open (for example, Address 0x13), this address location should not be written.

Default Values

After the AD6655 is reset, critical registers are loaded with default values. The default values for the registers are given in the memory map register table, Table 29.

Logic Levels

An explanation of logic level terminology follows:

- “Bit is set” is synonymous with “bit is set to Logic 1” or “writing Logic 1 for the bit.”
- “Clear a bit” is synonymous with “bit is set to Logic 0” or “writing Logic 0 for the bit.”

Transfer Register Map

Address 0x08 to Address 0x18 and Address 0x11E to Address 0x123 are shadowed. Writes to these addresses do not affect part operation until a transfer command is issued by writing 0x01 to Address 0xFF, setting the transfer bit. This allows these registers to be updated internally and simultaneously when the transfer bit is set. The internal update takes place when the transfer bit is set, and the bit autoclears.

Channel-Specific Registers

Some channel setup functions, such as the signal monitor thresholds, can be programmed differently for each channel. In these cases, channel address locations are internally duplicated for each channel. These registers and bits are designated in Table 29 as local. These local registers and bits can be accessed by setting the appropriate Channel A or Channel B bits in Register 0x05. If both bits are set, the subsequent write affects the registers of both channels. In a read cycle, only Channel A or Channel B should be set to read one of the two registers. If both bits are set during an SPI read cycle, the part returns the value for Channel A. Registers and bits designated as global in Table 29 affect the entire part or the channel features where independent settings are not allowed between channels. The settings in Register 0x05 do not affect the global registers and bits.

MEMORY MAP REGISTER TABLE

All address and bit locations that are not included in Table 29 are not currently supported for this device.

Table 29. Memory Map Registers

Addr. (Hex)	Register Name	Bit 7 (MSB)	Bit 6	Bit 5	Bit 4	Bit 3	Bit 2	Bit 1	Bit 0 (LSB)	Default Value (Hex)	Default Notes/ Comments
Chip Configuration Registers											
0x00	SPI Port Configuration (Global)	0	LSB first	Soft reset	1	1	Soft reset	LSB first	0	0x18	The nibbles are mirrored so that LSB-first or MSB-first mode registers correctly, regardless of shift mode
0x01	Chip ID (Global)	8-bit Chip ID[7:0] (AD6655 = 0x0D) (default)								0x0D	Default is unique chip ID, different for each device; this is a read-only register
0x02	Chip Grade (Global)	Open	Open	Speed Grade ID[4:3] 00 = 150 MSPS 01 = 125 MSPS 10 = 105 MSPS 11 = 80 MSPS	Open	Open	Open	Open	Open		Speed grade ID used to differentiate devices; this is a read-only register
Channel Index and Transfer Registers											
0x05	Channel Index	Open	Open	Open	Open	Open	Open	Data Channel B (default)	Data Channel A (default)	0x03	Bits are set to determine which device on chip receives the next write command; applies to local registers
0xFF	Transfer	Open	Open	Open	Open	Open	Open	Open	Transfer	0x00	Synchronously transfers data from the master shift register to the slave
ADC Function Registers											
0x08	Power Modes	Open	Open	External power-down pin function (global) 0 = pdwn 1 = stndby	Open	Open	Open	Internal power-down mode (local) 00 = normal operation 01 = full power-down 10 = standby 11 = normal operation		0x00	Determines various generic modes of chip operation
0x09	Global Clock (Global)	Open	Open	Open	Open	Open	Open	Open	Duty cycle stabilize (default)	0x01	
0x0B	Clock Divide (Global)	Open	Open	Open	Open	Open	Clock divide ratio 000 = divide by 1 001 = divide by 2 010 = divide by 3 011 = divide by 4 100 = divide by 5 101 = divide by 6 110 = divide by 7 111 = divide by 8		0x00	Clock divide values other than 000 automatically activate duty cycle stabilization	

AD6655

Addr. (Hex)	Register Name	Bit 7 (MSB)	Bit 6	Bit 5	Bit 4	Bit 3	Bit 2	Bit 1	Bit 0 (LSB)	Default Value (Hex)	Default Notes/Comments
0x0D	Test Mode (Local)	Open	Open	Reset PN long sequence	Reset PN short sequence	Open		Output test mode 000 = off (default) 001 = midscale short 010 = positive FS 011 = negative FS 100 = alternating checkerboard 101 = PN long sequence 110 = PN short sequence 111 = one/zero word toggle	0x00	When enabled, the test data is placed on the output pins in place of ADC output data	
0x10	Offset Adjust (Local)	Open	Open	Offset adjust in LSBs from +31 to -32 (twos complement format)						0x00	
0x14	Output Mode	Drive strength 0 V to 3.3 V CMOS or ANSI LVDS; 1 V to 1.8 V CMOS or reduced LVDS (global)	Output type 0 = CMOS 1 = LVDS (global)	Interleaved CMOS (global)	Output enable bar (local)	Open	Output invert (local)	00 = offset binary 01 = twos complement 11 = offset binary (local)	0x00	Configures the outputs and the format of the data	
0x16	Clock Phase Control (Global)	Invert DCO clock	Open	Open	Open	Open	Input clock divider phase adjust 000 = no delay 001 = 1 input clock cycle 010 = 2 input clock cycles 011 = 3 input clock cycles 100 = 4 input clock cycles 101 = 5 input clock cycles 110 = 6 input clock cycles 111 = 7 input clock cycles		0x00	Allows selection of clock delays into the input divider	
0x17	DCO Output Delay (Global)	Open	Open	Open	DCO clock delay (delay = 2500 ps × register value/31) 00000 = 0 ps 00001 = 81 ps 00010 = 161 ps ... 11110 = 2419 ps 11111 = 2500 ps				0x00		
0x18	VREF Select (Global)	Reference voltage selection 00 = 1.25 V p-p 01 = 1.5 V p-p 10 = 1.75 V p-p 11 = 2.0 V p-p (default)		Open	Open	Open	Open	Open	Open	0xC0	
Digital Feature Control Registers											
0x100	Sync Control (Global)	Signal monitor sync enable	Half-band next sync only	Half-band sync enable	NCO32 next sync only	NCO32 sync enable	Clock divider next sync only	Clock divider sync enable	Master sync enable	0x00	
0x101	f _s /8 Output Mix Control (Global)	Open	Open	f _s /8 start state		Open	Open	f _s /8 next sync only	f _s /8 sync enable	0x00	
0x102	FIR Filter and Output Mode Control (Global)	Open	Open	Open	Open	FIR gain 0 = gain of 2 1 = gain of 1	f _s /8 output mix disable	Complex output enable	FIR filter enable	0x00	
0x103	Digital Filter Control (Global)	Open	Open	Open	Open	Half-band decimation phase	Spectral reversal	High-pass/low-pass select	Open	0x01	

Addr. (Hex)	Register Name	Bit 7 (MSB)	Bit 6	Bit 5	Bit 4	Bit 3	Bit 2	Bit 1	Bit 0 (LSB)	Default Value (Hex)	Default Notes/ Comments
0x104	Fast Detect Control (Local)	Open	Open	Open	Open	Fast Detect Mode Select[2:0]			Fast detect enable	0x00	
0x105	Coarse Upper Threshold (Local)	Open	Open	Open	Open	Open	Coarse Upper Threshold[2:0]			0x00	
0x106	Fine Upper Threshold Register 0 (Local)	Fine Upper Threshold[7:0]								0x00	
0x107	Fine Upper Threshold Register 1 (Local)	Open	Open	Open	Fine Upper Threshold[12:8]					0x00	
0x108	Fine Lower Threshold Register 0 (Local)	Fine Lower Threshold[7:0]								0x00	
0x109	Fine Lower Threshold Register 1 (Local)	Open	Open	Open	Fine Lower Threshold[12:8]					0x00	
0x10A	Increase Gain Dwell Time Register 0 (Local)	Increase Gain Dwell Time[7:0]								0x00	In ADC clock cycles
0x10B	Increase Gain Dwell Time Register 1 (Local)	Increase Gain Dwell Time[15:8]								0x00	In ADC clock cycles
0x10C	Signal Monitor DC Correction Control (Global)	Open	DC correction freeze	DC Correction Bandwidth(k[3:0])			DC correction for signal path enable	DC correction for signal monitor enable		0x00	
0x10D	Signal Monitor DC Value Channel A Register 0 (Global)	DC Value Channel A[7:0]									Read only
0x10E	Signal Monitor DC Value Channel A Register 1 (Global)	Open	Open	DC Value Channel A[13:8]						Read only	
0x10F	Signal Monitor DC Value Channel B Register 0 (Global)	DC Value Channel B[7:0]									Read only
0x110	Signal Monitor DC Value Channel B Register 1 (Global)	Open	Open	DC Value Channel B[13:8]						Read only	
0x111	Signal Monitor SPORT Control (Global)	Open	RMS magnitude output enable	Peak detector output enable	Threshold crossing output enable	SPORT SMI SCLK divide 00 = Undefined 01 = divide by 2 10 = divide by 4 11 = divide by 8	SPORT SMI SCLK sleep	Signal monitor SPORT output enable		0x04	

AD6655

Addr. (Hex)	Register Name	Bit 7 (MSB)	Bit 6	Bit 5	Bit 4	Bit 3	Bit 2	Bit 1	Bit 0 (LSB)	Default Value (Hex)	Default Notes/ Comments
0x112	Signal Monitor Control (Global)	Complex power calculation mode enable	Open	Open	Open	Signal monitor rms/ms select 0 = rms 1 = ms	Signal monitor mode 00 = rms/ms magnitude 01 = peak detector 10 = threshold crossing 11 = threshold crossing		Signal monitor enable	0x00	
0x113	Signal Monitor Period Register 0 (Global)	Signal Monitor Period[7:0]								0x80	In ADC clock cycles
0x114	Signal Monitor Period Register 1 (Global)	Signal Monitor Period[15:8]								0x00	1 In ADC clock cycles
0x115	Signal Monitor Period Register 2 (Global)	Signal Monitor Period[23:16]								0x00	In ADC clock cycles
0x116	Signal Monitor Result Channel A Register 0 (Global)	Signal Monitor Result Channel A[7:0]									Read only
0x117	Signal Monitor Result Channel A Register 1 (Global)	Signal Monitor Result Channel A[15:8]									Read only
0x118	Signal Monitor Result Channel A Register 2 (Global)	Open	Open	Open	Open	Signal Monitor Result Channel A[19:16]				Read only	
0x119	Signal Monitor Result Channel B Register 0 (Global)	Signal Monitor Result Channel B[7:0]									Read only
0x11A	Signal Monitor Result Channel B Register 1 (Global)	Signal Monitor Result Channel B[15:8]									Read only
0x11B	Signal Monitor Result Channel B Register 2 (Global)	Open	Open	Open	Open	Signal Monitor Result Channel B[19:16]				Read only	
0x11D	NCO Control (Global)	Open	Open	Open	Open	Open	NCO32 phase dither enable	NCO32 amplitude dither enable	NCO32 enable	0x00	
0x11E	NCO Frequency 0	NCO Frequency Value[7:0]								0x00	
0x11F	NCO Frequency 1	NCO Frequency Value[15:8]								0x00	
0x120	NCO Frequency 2	NCO Frequency Value[23:16]								0x00	

Addr. (Hex)	Register Name	Bit 7 (MSB)	Bit 6	Bit 5	Bit 4	Bit 3	Bit 2	Bit 1	Bit 0 (LSB)	Default Value (Hex)	Default Notes/Comments
0x121	NCO Frequency 3	NCO Frequency Value[31:24]								0x00	
0x122	NCO Phase Offset 0	NCO Phase Value[7:0]								0x00	
0x123	NCO Phase Offset 1	NCO Phase Value[15:8]								0x00	

MEMORY MAP REGISTER DESCRIPTION

For more information on functions controlled in Register 0x00 to Register 0xFF, see Application Note AN-877, *Interfacing to High Speed ADCs via SPI*, at www.analog.com.

SYNC Control (Register 0x100)

Bit 7—Signal Monitor Sync Enable

Bit 7 enables the sync pulse from the external sync input to the signal monitor block. The sync signal is passed when Bit 7 and Bit 0 are high. This is continuous sync mode.

Bit 6—Half-Band Next Sync Only

If the master sync enable bit (Register 0x100, Bit 0) and the half-band sync enable bit (Register 0x100, Bit 5) are high, Bit 6 allows the NCO32 to synchronize following the first sync pulse it receives and ignore the rest. If Bit 6 is set, Bit 5 of Register 0x100 resets after this sync occurs.

Bit 5—Half-Band Sync Enable

Bit 5 gates the sync pulse to the half-band filter. When Bit 5 is set high, the sync signal causes the half-band to resynchronize, starting at the half-band decimation phase selected in Register 0x103, Bit 3. This sync is active only when the master sync enable bit (Register 0x100, Bit 0) is high. This is continuous sync mode.

Bit 4—NCO32 Next Sync Only

If the master sync enable bit (Register 0x100, Bit 0) and the NCO32 sync enable bit (Register 0x100, Bit 3) are high, Bit 4 allows the NCO32 to synchronize following the first sync pulse it receives and ignore the rest. Bit 3 of Register 0x100 resets after a sync occurs if Bit 4 is set.

Bit 3—NCO32 Sync Enable

Bit 3 gates the sync pulse to the 32-bit NCO. When this bit is set high, the sync signal causes the NCO to resynchronize, starting at the NCO phase offset value. This sync is active only when the master sync enable bit (Register 0x100, Bit 0) is high. This is continuous sync mode.

Bit 2—Clock Divider Next Sync Only

If the master sync enable bit (Register 0x100, Bit 0) and the clock divider sync enable bit (Register 0x100, Bit 1) are high, Bit 2 allows the clock divider to synchronize following the first sync pulse it receives and ignores the rest. Bit 1 of Register 0x100 resets after it synchronizes.

Bit 1—Clock Divider Sync Enable

Bit 1 gates the sync pulse to the clock divider. The sync signal is passed when Bit 1 and Bit 0 are high. This is continuous sync mode.

Bit 0—Master Sync Enable

Bit 0 must be high to enable any of the sync functions.

$f_s/8$ Output Mix Control (Register 0x101)

Bits[7:6]—Reserved

Bits[5:4]— $f_s/8$ Start State

Bit 5 and Bit 4 set the starting phase of the $f_s/8$ output mix.

Bits[3:2]—Reserved

Bit 1— $f_s/8$ Next Sync Only

If the master sync enable bit (Register 0x100, Bit 0) and the $f_s/8$ sync enable bit (Register 0x101, Bit 0) are high, Bit 1 allows the $f_s/8$ output mix to synchronize following the first sync pulse it receives and ignore the rest. Bit 0 of Register 0x100 resets after it synchronizes.

Bit 0— $f_s/8$ Sync Enable

Bit 0 gates the sync pulse to the $f_s/8$ output mix. This sync is active only when the master sync enable bit (Register 0x100, Bit 0) is high. This is continuous sync mode.

FIR Filter and Output Mode Control (Register 0x102)

Bits[7:4]—Reserved

Bit 3—FIR Gain

When Bit 3 is set high, the FIR filter path, if enabled, has a gain of 1. When Bit 3 set low, the FIR filter path has a gain of 2.

Bit 2— $f_s/8$ Output Mix Disable

Bit 2 disables the $f_s/8$ output mix when enabled. Bit 2 should be set along with Bit 1 to enable complex output mode.

Bit 1—Complex Output Mode Enable

Setting Bit 1 high enables complex output mode.

Bit 0—FIR Filter Enable

When set high, Bit 0 enables the FIR filter. When Bit 0 is cleared, the FIR filter is bypassed and shut down for power savings.

Digital Filter Control (Register 0x103)

Bits[7:4]—Reserved

Bit 3—Half-Band Decimation Phase

When set high, Bit 3 uses the alternate phase of the decimating half-band filter.

Bit 2—Spectral Reversal

Bit 2 enables the spectral reversal feature of the half-band filter.

Bit 1—High-Pass/Low-Pass Select

Bit 1 enables the high-pass mode of the half-band filter when set high. Setting this bit low enables the low-pass mode (default).

Bit 0—Reserved

Bit 0 reads back as a 1.

Fast Detect Control (Register 0x104)

Bits[7:4]—Reserved

Bits[3:1]—Fast Detect Mode Select

Bits[3:1] set the mode of the fast detect output bits according to Table 29.

Bit 0—Fast Detect Enable

Bit 0 is used to enable the fast detect output pins. When the FD outputs are disabled, the outputs go into a high impedance state. In LVDS mode when the outputs are interleaved, the outputs go high-Z only if both channels are turned off (power-down/standby/output disabled). If only one channel is turned off (power-down/standby/output disabled), the fast detect outputs repeat the data of the active channel.

Coarse Upper Threshold (Register 0x105)

Bits[7:3]—Reserved

Bits[2:0]—Coarse Upper Threshold

These bits set the level required to assert the coarse upper threshold indication (see Table 25).

Fine Upper Threshold (Register 0x106 and Register 0x107)

Register 0x107, Bits[7:5]—Reserved

Register 0x107, Bits[4:0]—Fine Upper Threshold Bits[12:8]

Register 0x106, Bits[7:0]—Fine Upper Threshold Bits[7:0]

These registers provide a fine upper limit threshold. The 13-bit value is compared to the 13-bit magnitude from the ADC block. If the ADC magnitude exceeds this threshold value, the F_UT indicator is set.

Fine Lower Threshold (Register 0x108 and Register 0x109)

Register 0x109, Bits[7:5]—Reserved

Register 0x109, Bits[4:0]—Fine Lower Threshold Bits[12:8]

Register 0x108, Bits[7:0]—Fine Lower Threshold Bits[7:0]

These registers provide a fine lower limit threshold. This 13-bit value is compared with the 13-bit magnitude from the ADC block. If the ADC magnitude is less than this threshold value, the F_LT indicator is set.

Increase Gain Dwell Time (Register 0x10A and Register 0x10B)

Register 0x10B, Bits[7:0]—Increase Gain Dwell Time Bits[15:8]

Register 0x10A, Bits[7:0]—Increase Gain Dwell Time Bits[7:0]

These register values set the minimum time in ADC sample clock cycles (after clock divider) that a signal needs to stay below the fine lower threshold limit before the F_LT and IG are asserted high.

Signal Monitor DC Correction Control (Register 0x10C)

Bit 7—Reserved

Bit 6—DC Correction Freeze

When Bit 6 is set high, the dc correction is no longer updated to the signal monitor block, which holds the last dc value calculated.

Bits[5:2]—DC Correction Bandwidth

Bits[5:2] set the averaging time of the signal monitor dc correction function. This 4-bit word sets the bandwidth of the correction block, according to the following equation:

$$DC_Corr_BW = 2^{-k-14} \times \frac{f_{CLK}}{2 \times \pi}$$

where:

k is the 4-bit value programmed in Bits[5:2] of Register 0x10C (values between 0 and 13 are valid for k ; programming 14 or 15 provides the same result as programming 13).

f_{CLK} is the AD6655 ADC sample rate in hertz (Hz).

Bit 1—DC Correction for Signal Path Enable

Setting this bit high causes the output of the dc measurement block to be summed with the data in the signal path to remove the dc offset from the signal path.

Bit 0—DC Correction for Signal Monitor Enable

This bit enables the dc correction function in the signal monitor block. The dc correction is an averaging function that can be used by the signal monitor to remove dc offset in the signal. Removing this dc from the measurement allows a more accurate power reading.

Signal Monitor DC Value Channel A (Register 0x10D and Register 0x10E)

Register 0x10E, Bits[7:6]—Reserved

Register 0x10E, Bits[5:0]—DC Value Channel A[13:8]

Register 0x10D, Bits[7:0]—DC Value Channel A[7:0]

These read-only registers hold the latest dc offset value computed by the signal monitor for Channel A.

Signal Monitor DC Value Channel B (Register 0x10F and Register 0x110)

Register 0x110, Bits[7:6]—Reserved

Register 0x110, Bits[5:0]—Channel B DC Value Bits[13:8]

Register 0x10F, Bits[7:0]—Channel B DC Value Bits [7:0]

These read-only registers hold the latest dc offset value computed by the signal monitor for Channel B.

Signal Monitor SPORT Control (Register 0x111)

Bit 7—Reserved

Bit 6—RMS/MS Magnitude Output Enable

Bit 6 enables the 20-bit rms or ms magnitude measurement as output on the SPORT.

Bit 5—Peak Detector Output Enable

Bit 5 enables the 13-bit peak measurement as output on the SPORT.

Bit 4—Threshold Crossing Output Enable

Bit 4 enables the 13-bit threshold measurement as output on the SPORT.

Bits[3:2]—SPORT SMI SCLK Divide

The values of these bits set the SPORT SMI SCLK divide ratio from the input clock. A value of 0x01 sets divide by 2 (default), a value of 0x10 sets divide by 4, and a value of 0x11 sets divide by 8.

Bit 1—SPORT SMI SCLK Sleep

Setting Bit 1 high causes the SMI SCLK to remain low when the signal monitor block has no data to transfer.

Bit 0—Signal Monitor SPORT Output Enable

When set, Bit 0 enables the signal monitor SPORT output to begin shifting out the result data from the signal monitor block.

Signal Monitor Control (Register 0x112)

Bit 7—Complex Power Calculation Mode Enable

This mode assumes I data is present on one channel and Q data is present on the alternate channel. The result reported is the complex power measured as

$$\sqrt{I^2 + Q^2}$$

Bits[6:4]—Reserved

Bit 3—Signal Monitor RMS/MS Select

Setting Bit 3 low selects rms power measurement mode. Setting Bit 3 high selects ms power measurement mode.

Bits[2:1]—Signal Monitor Mode

Bit 2 and Bit 1 set the mode of the signal monitor for data output to registers at Address 0x116 through Address 0x11B. Setting these bits to 0x00 selects rms/ms magnitude output, setting these bits to 0x01 selects peak detector output, and setting 0x10 or 0x11 selects threshold crossing output.

Bit 0—Signal Monitor Enable

Setting Bit 0 high enables the signal monitor block.

Signal Monitor Period (Register 0x113 to Register 0x115)

Register 0x115 Bits[7:0]—Signal Monitor Period[23:16]

Register 0x114 Bits[7:0]—Signal Monitor Period[15:8]

Register 0x113 Bits[7:0]—Signal Monitor Period[7:0]

This 24-bit value sets the number of clock cycles over which the signal monitor performs its operation. The minimum value for this register is 128 cycles (programmed values less than 128 revert to 128).

Signal Monitor Result Channel A (Register 0x116 to Register 0x118)

Register 0x118, Bits[7:4]—Reserved

Register 0x118, Bits[3:0]—Signal Monitor Result Channel A[19:16]

Register 0x117, Bits[7:0]—Signal Monitor Result Channel A[15:8]

Register 0x116, Bits[7:0]—Signal Monitor Result Channel A[7:0]

This 20-bit value contains the power value calculated by the signal monitor block for Channel A. The content is dependent on the settings in Register 0x112, Bits[2:1].

Signal Monitor Result Channel B (Register 0x119 to Register 0x11B)

Register 0x11B, Bits[7:4]—Reserved

Register 0x11B, Bits[3:0]—Signal Monitor Result Channel B[19:16]

Register 0x11A, Bits[7:0]—Signal Monitor Result Channel B[15:8]

Register 0x119, Bits[7:0]—Signal Monitor Result Channel B[7:0]

This 20-bit value contains the power value calculated by the signal monitor block for Channel B. The content is dependent on the settings in Register 0x112, Bits[2:1].

NCO Control (Register 0x11D)

Bits[7:3]—Reserved

Bit 2—NCO32 Phase Dither Enable

When Bit 2 is set, phase dither in the NCO is enabled. When Bit 2 is cleared, phase dither is disabled.

Bit 1—NCO32 Amplitude Dither Enable

When Bit 1 is set, amplitude dither in the NCO is enabled. When Bit 1 is cleared, amplitude dither is disabled.

AD6655

Bit 0—NCO32 Enable

When Bit 0 is set, this bit enables the 32-bit NCO operating at the frequency programmed into the NCO frequency register. When Bit 0 is cleared, the NCO is bypassed and shuts down for power savings.

NCO Frequency (Register 0x11E to Register 0x121)

Register 0x11E, Bits[7:0]—NCO Frequency Value[7:0]

Register 0x11F, Bits[7:0]—NCO Frequency Value[15:8]

Register 0x120, Bits[7:0]—NCO Frequency Value[23:16]

Register 0x121, Bits[7:0]—NCO Frequency Value[31:24]

This 32-bit value is used to program the NCO tuning frequency.

The frequency value to be programmed is given by the following equation:

$$NCO_FREQ = 2^{32} \times \frac{Mod(f, f_{CLK})}{f_{CLK}}$$

where:

NCO_FREQ is a 32-bit twos complement number representing the NCO frequency register.

f is the desired carrier frequency in hertz (Hz).

f_{CLK} is the AD6655 ADC clock rate in hertz (Hz).

NCO Phase Offset (Register 0x122 and Register 0x123)

Register 0x122, Bits[7:0]—NCO Phase Value[7:0]

Register 0x123, Bits[7:0]—NCO Phase Value[15:8]

The 16-bit value programmed into the NCO phase value register is loaded into the NCO block each time the NCO is started or when an NCO SYNC signal is received. This process allows the NCO to be started with a known nonzero phase.

Use the following equation to calculate the NCO phase offset value:

$$NCO_PHASE = 2^{16} \times PHASE/360$$

where:

NCO_PHASE is a decimal number equal to the 16-bit binary number to be programmed at Register 0x122 and Register 0x123.
 $PHASE$ is the desired NCO phase in degrees.

APPLICATIONS INFORMATION

DESIGN GUIDELINES

Before starting system-level design and layout of the AD6655, it is recommended that the designer become familiar with these guidelines, which discuss the special circuit connections and layout requirements needed for certain pins.

Power and Ground Recommendations

When connecting power to the AD6655, it is recommended that two separate 1.8 V supplies be used: one supply should be used for analog (AVDD) and digital (DVDD), and a separate supply should be used for the digital outputs (DRVDD). The AVDD and DVDD supplies, while derived from the same source, should be isolated with a ferrite bead or filter choke and separate decoupling capacitors. The designer can employ several different decoupling capacitors to cover both high and low frequencies. These capacitors should be located close to the point of entry at the PC board level and close to the pins of the part with minimal trace length.

A single PCB ground plane should be sufficient when using the AD6655. With proper decoupling and smart partitioning of the PCB analog, digital, and clock sections, optimum performance is easily achieved.

$f_s/2$ Spurious

Because the AD6655 output data rate is at one-half the sampling frequency, there is significant $f_s/2$ energy in the outputs of the part. If this $f_s/2$ spur falls in band, care must be taken to ensure that this $f_s/2$ energy does not couple into either the clock circuit or the analog inputs of the AD6655. When $f_s/2$ energy is coupled in this fashion, it appears as a spurious tone reflected around $f_s/4$, $3f_s/4$, $5f_s/4$, and so on. For example, in a 125 MSPS sampling application with a 90 MHz single-tone analog input, this energy generates a tone at 97.5 MHz. In this example, the center of the Nyquist zone is 93.75 MHz; therefore, the 90 MHz input signal is 3.75 MHz from the center of the Nyquist zone. As a result, the $f_s/2$ spurious tone appears at 97.5 MHz, or 3.75 MHz above the center of the Nyquist zone. These frequencies are then tuned by the NCOs before being output by the AD6655.

Depending on the relationship of the IF frequency to the center of the Nyquist zone, this spurious tone may or may not exist in the AD6655 output band. Some residual $f_s/2$ energy is present in the AD6655, and the level of this spur is typically below the level of the harmonics at clock rates of 125 MSPS and below. Figure 82 shows a plot of the $f_s/2$ spur level vs. analog input frequency for the AD6655-125. At sampling rates above 125 MSPS, the $f_s/2$ spur level increases and is at a higher level than the worst harmonic, as shown in Figure 83, which shows the AD6655-150 $f_s/2$ levels.

For the specifications provided in Table 2, the $f_s/2$ spur, if in band, is excluded from the SNR values. It is treated as a harmonic, in terms of SNR. The $f_s/2$ level is included in the SFDR and worst other specifications.

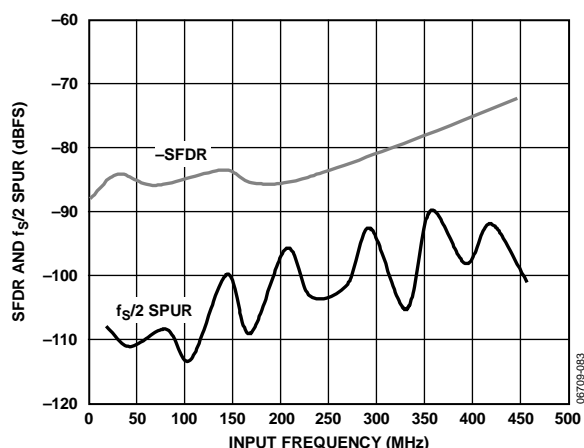

Figure 82. AD6655-125 SFDR and $f_s/2$ Spurious Level vs. Input Frequency (f_{IN}) with DRVDD = 1.8 V Parallel CMOS Output Mode

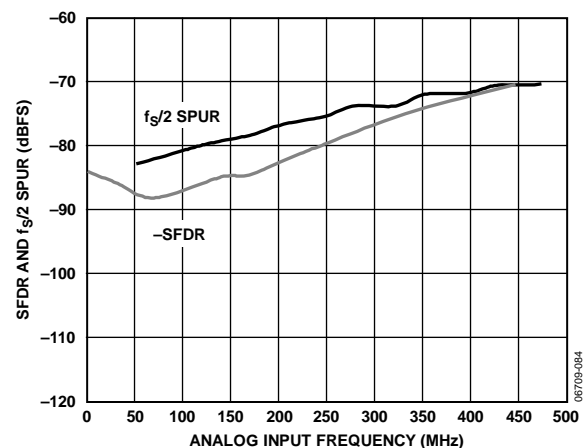

Figure 83. AD6655-150 SFDR and $f_s/2$ Spurious Level vs. Input Frequency (f_{IN}) with DRVDD = 1.8 V Parallel CMOS Output Mode

Operating the part with a 1.8 V DRVDD voltage rather than a 3.3 V DRVDD lowers the $f_s/2$ spur. In addition, using LVDS, CMOS interleaved, or CMOS IQ output modes also reduces the $f_s/2$ spurious level.

LVDS Operation

The AD6655 defaults to CMOS output mode on power-up. If LVDS operation is desired, this mode must be programmed using the SPI configuration registers after power-up. When the AD6655 powers up in CMOS mode with LVDS termination resistors (100 Ω) on the outputs, the DRVDD current can be higher than the typical value until the part is placed in LVDS mode. This additional DRVDD current does not cause damage to the AD6655, but it should be taken into account when considering the maximum DRVDD current for the part.

AD6655

To avoid this additional DRVDD current, the AD6655 outputs can be disabled at power-up by taking the OEB pin high. After the part is placed into LVDS mode via the SPI port, the OEB pin can be taken low to enable the outputs.

Exposed Paddle Thermal Heat Slug Recommendations

It is mandatory that the exposed paddle on the underside of the ADC be connected to analog ground (AGND) to achieve the best electrical and thermal performance. A continuous, exposed (no solder mask) copper plane on the PCB should mate to the AD6655 exposed paddle, Pin 0.

The copper plane should have several vias to achieve the lowest possible resistive thermal path for heat dissipation to flow through the bottom of the PCB. These vias should be filled or plugged with nonconductive epoxy.

To maximize the coverage and adhesion between the ADC and the PCB, a silkscreen should be overlaid to partition the continuous plane on the PCB into several uniform sections. This provides several tie points between the ADC and the PCB during the reflow process. Using one continuous plane with no partitions guarantees only one tie point between the ADC and the PCB. See the evaluation board for a PCB layout example. For detailed information about packaging and PCB layout of chip scale packages, refer to Application Note AN-772, *A Design and Manufacturing Guide for the Lead Frame Chip Scale Package (LFCSP)* (see www.analog.com).

CML

The CML pin should be decoupled to ground with a 0.1 μF capacitor, as shown in Figure 48.

RBIAS

The AD6655 requires that a 10 k Ω resistor be placed between the RBIAS pin and ground. This resistor sets the master current reference of the ADC core and should have at least a 1% tolerance.

Reference Decoupling

The VREF pin should be externally decoupled to ground with a low ESR, 1.0 μF capacitor in parallel with a low ESR, 0.1 μF ceramic capacitor.

SPI Port

The SPI port should not be active during periods when the full dynamic performance of the converter is required. Because the SCLK, CSB, and SDIO signals are typically asynchronous to the ADC clock, noise from these signals can degrade converter performance. If the on-board SPI bus is used for other devices, it may be necessary to provide buffers between this bus and the AD6655 to keep these signals from transitioning at the converter inputs during critical sampling periods.

EVALUATION BOARD

The AD6655 evaluation board provides all of the support circuitry required to operate the ADC in its various modes and configurations. The converter can be driven differentially through a double balun configuration (default) or optionally through the AD8352 differential driver. The ADC can also be driven in a single-ended fashion. Separate power pins are provided to isolate the DUT from the AD8352 drive circuitry. Each input configuration can be selected by proper connection of various components (see Figure 85 to Figure 94). Figure 84 shows the typical bench characterization setup used to evaluate the ac performance of the AD6655.

It is critical that the signal sources used for the analog input and clock have very low phase noise ($\ll 1$ ps rms jitter) to realize the optimum performance of the converter. Proper filtering of the analog input signal to remove harmonics and lower the integrated or broadband noise at the input is also necessary to achieve the specified noise performance.

See Figure 85 to Figure 102 for the complete schematics and layout diagrams that demonstrate the routing and grounding techniques that should be applied at the system level.

POWER SUPPLIES

This evaluation board comes with a wall-mountable switching power supply that provides a 6 V, 2 A maximum output. Connect the supply to the rated 100 V ac to 240 V ac wall outlet at 47 Hz to 63 Hz. The output of the supply is a 2.1 mm inner diameter circular jack that connects to the PCB at J16. Once on the PC board, the 6 V supply is fused and conditioned before connection to six low dropout linear regulators that supply the proper bias to each of the various sections on the board.

External supplies can be used to operate the evaluation board by removing L1, L3, L4, and L13 to disconnect the voltage regulators supplied from the switching power supply. This enables the user to individually bias each section of the board. Use P3 and P4 to connect a different supply for each section. At least one 1.8 V supply is needed with a 1 A current capability for AVDD and DVDD; a separate 1.8 V to 3.3 V supply is recommended for DRVDD. To operate the evaluation board using the AD8352 option, a separate 5.0 V supply (AMP VDD) with a 1 A current capability is needed. To operate the evaluation board using the alternate SPI options, a separate 3.3 V analog supply (VS) is needed, in addition to the other supplies. The 3.3 V supply (VS) should have a 1 A current capability, as well. Solder Jumper SJ35 allows the user to separate AVDD and DVDD, if desired.

INPUT SIGNALS

When connecting the clock and analog source, use clean signal generators with low phase noise, such as the Rohde & Schwarz SMA100A signal generators or the equivalent. Use 1 m long, shielded, RG-58, 50 Ω coaxial cable for making connections to the evaluation board. Enter the desired frequency and amplitude for the ADC. The AD6655 evaluation board from Analog Devices, Inc., can accept a ~ 2.8 V p-p or 13 dBm sine wave input for the clock. When connecting the analog input source, it is recommended that a multipole, narrow-band, band-pass filter with 50 Ω terminations be used. Band-pass filters of this type are available from TTE, Allen Avionics, and K&L Microwave, Inc. Connect the filter directly to the evaluation board, if possible.

OUTPUT SIGNALS

The parallel CMOS outputs interface directly with the Analog Devices standard ADC data capture board (HSC-ADC-EVALCZ). For more information on the ADC data capture boards and their optional settings, visit www.analog.com/FIFO.

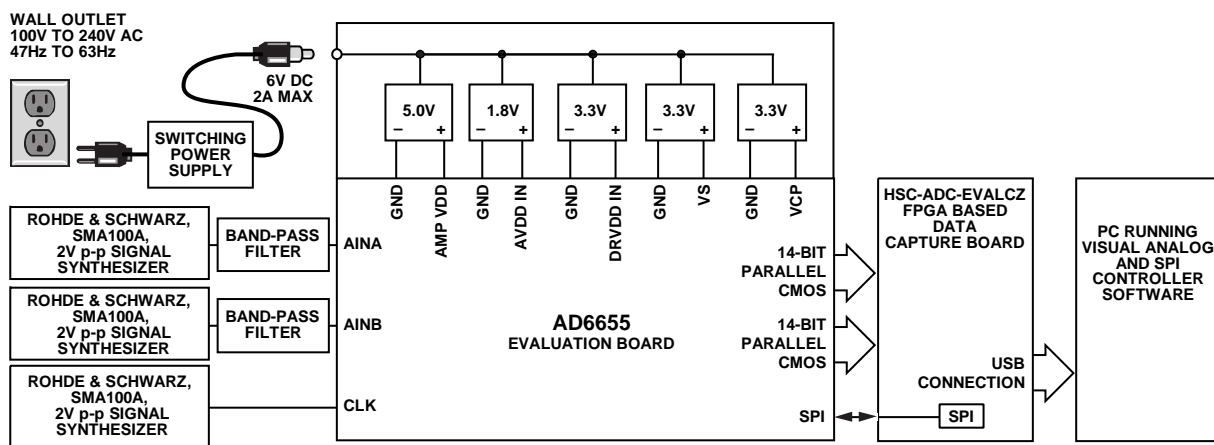

Figure 84. Evaluation Board Connection

DEFAULT OPERATION AND JUMPER SELECTION SETTINGS

The following is a list of the default and optional settings or modes allowed on the AD6655 evaluation board.

POWER

Connect the switching power supply that is provided in the evaluation kit between a rated 100 V ac to 240 V ac wall outlet at 47 Hz to 63 Hz and P500.

VIN

The evaluation board is set up for a double balun configuration analog input with optimum 50 Ω impedance matching from 70 MHz to 200 MHz. For more bandwidth response, the differential capacitor across the analog inputs can be changed or removed (see Table 14). The common mode of the analog inputs is developed from the center tap of the transformer via the CML pin of the ADC (see the Analog Input Considerations section).

VREF

VREF is set to 1.0 V by tying the SENSE pin to ground by adding a jumper on Header J5 (Pin 1 to Pin 2). This causes the ADC to operate in 2.0 V p-p full-scale range. To place the ADC in 1.0 V p-p mode (VREF = 0.5 V), a jumper should be placed on Header J4. A separate external reference option is also included on the evaluation board. To use an external reference, connect J6 (Pin 1 to Pin 2) and provide an external reference at TP5. Proper use of the VREF options is detailed in the Voltage Reference section.

RBIAS

RBIAS requires a 10 k Ω resistor (R503) to ground and is used to set the ADC core bias current.

CLOCK

The default clock input circuitry is derived from a simple balun-coupled circuit using a high bandwidth 1:1 impedance ratio balun (T5) that adds a very low amount of jitter to the clock path. The clock input is 50 Ω terminated and ac-coupled to handle single-ended sine wave inputs. The transformer converts the single-ended input to a differential signal that is clipped before entering the ADC clock inputs. When the AD6655 input clock divider is utilized, clock frequencies up to 625 MHz can be input into the evaluation board through Connector S5.

PDWN

To enable the power-down feature, connect J7, shorting the PDWN pin to AVDD.

CSB

The CSB pin is internally pulled up, setting the chip into external pin mode, to ignore the SDIO and SCLK information. To connect the control of the CSB pin to the SPI circuitry on the evaluation board, connect J21, Pin 1 to J21, Pin 2.

SCLK/DFS

If the SPI port is in external pin mode, the SCLK/DFS pin sets the data format of the outputs. If the pin is left floating, the pin is internally pulled down, setting the default data format condition to offset binary. Connecting J2, Pin 1 to J2, Pin 2 sets the format to twos complement. If the SPI port is in serial pin mode, connecting J2, Pin 2 to J2, Pin 3 connects the SCLK pin to the on-board SPI circuitry (see the Serial Port Interface (SPI) section).

SDIO/DCS

If the SPI port is in external pin mode, the SDIO/DCS pin sets the duty cycle stabilizer. If the pin is left floating, the pin is internally pulled up, setting the default condition to DCS enabled. To disable the DCS, connect J1, Pin 1 to J1, Pin 2. If the SPI port is in serial pin mode, connecting J1, Pin 2 to J1, Pin 3 connects the SDIO pin to the on-board SPI circuitry (see the Serial Port Interface (SPI) section).

ALTERNATIVE CLOCK CONFIGURATIONS

Two alternate clocking options are provided on the AD6655 evaluation board. The first option is to use an on-board crystal oscillator (Y1) to provide the clock input to the part. To enable this crystal, Resistor R8 (0 Ω) and Resistor R85 (10 k Ω) should be installed, and Resistor R82 and Resistor R30 should be removed.

A second clock option is to use a differential LVPECL clock to drive the ADC input using the AD9516 (U2). When using this drive option, the AD9516 charge pump filter components need to be populated (see Figure 89). Consult the AD9516 data sheet for more information.

To configure the clock input from S5 to drive the AD9516 reference input instead of directly driving the ADC, the following components need to be added, removed, and/or changed.

1. Remove R32, R33, R99, and R101 in the default clock path.
2. Populate C78 and C79 with 0.001 μ F capacitors and R78 and R79 with 0 Ω resistors in the clock path.

In addition, unused AD9516 outputs (one LVDS and one LVPECL) are routed to optional Connector S8 through Connector S11 on the evaluation board.

ALTERNATIVE ANALOG INPUT DRIVE CONFIGURATION

This section provides a brief description of the alternative analog input drive configuration using the [AD8352](#). When using this particular drive option, some additional components need to be populated. For more details on the AD8352 differential driver, including how it works and its optional pin settings, consult the AD8352 data sheet.

To configure the analog input to drive the AD8352 instead of the default transformer option, the following components need to be added, removed, and/or changed for Channel A. For Channel B, the corresponding components should be changed.

1. Remove C1, C17, C18, and C117 in the default analog input path.
2. Populate C8 and C9 with 0.1 μ F capacitors in the analog input path. To drive the AD8352 in the differential input mode, populate the T10 transformer; the R1, R37, R39, R126, and R127 resistors; and the C10, C11, and C125 capacitors.
3. Populate the optional amplifier output path with the desired components including an optional low-pass filter. Install 0 Ω resistors, R44 and R48. R43 and R47 should be increased (typically to 100 Ω) to increase to 200 Ω the output impedance seen by the AD8352.

SCHEMATICS

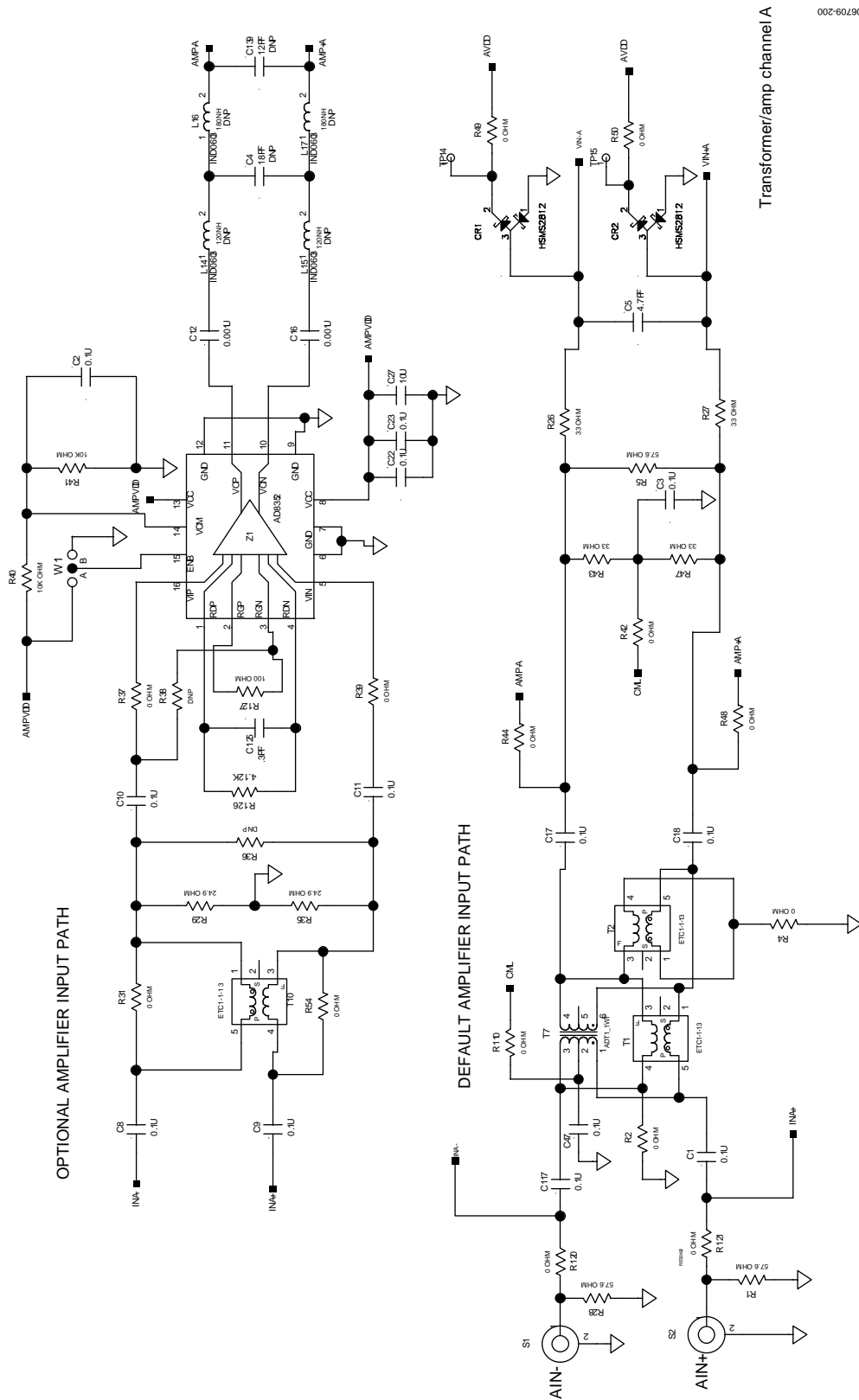

Figure 85. Evaluation Board Schematic, Channel A Analog Inputs

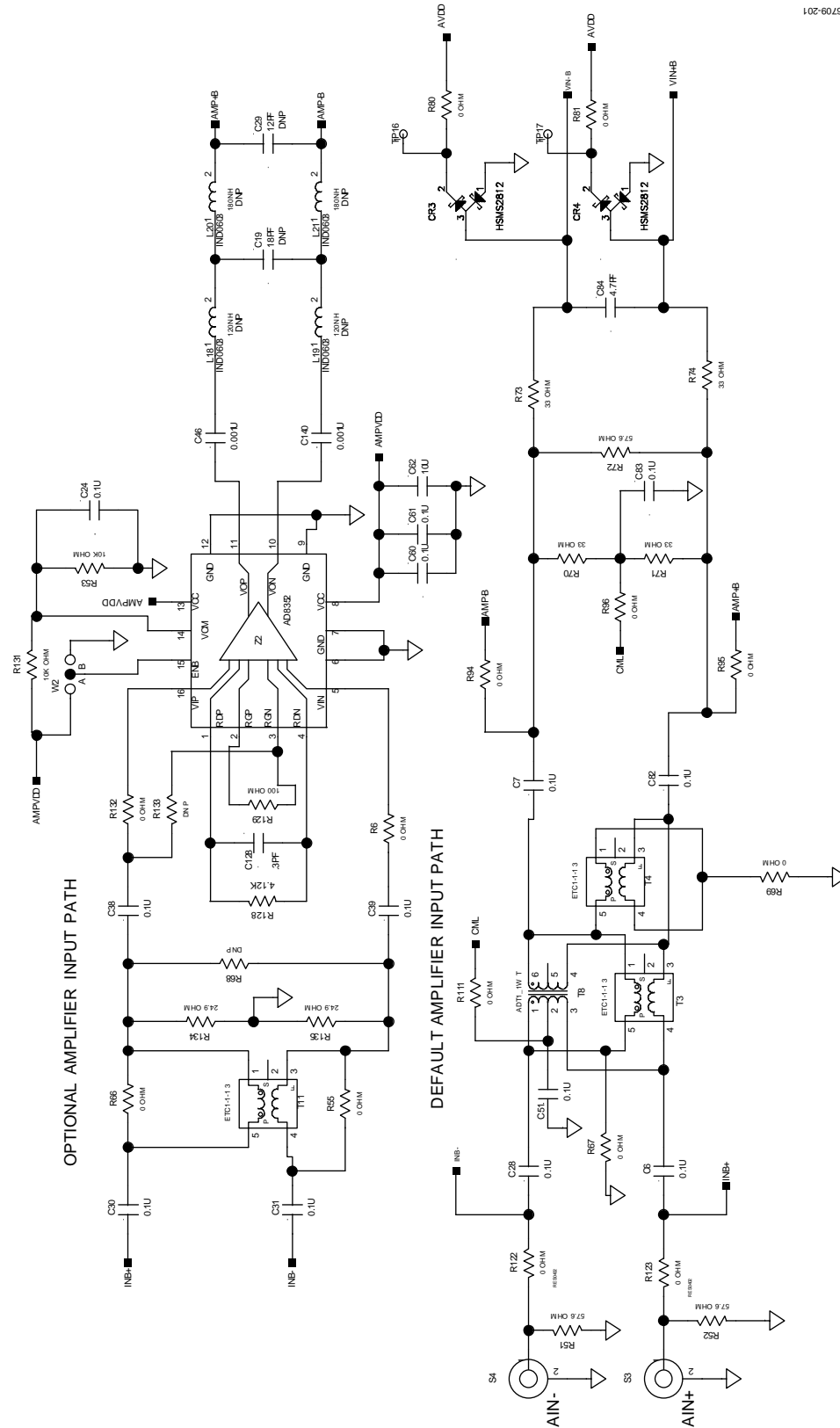

Figure 86. Evaluation Board Schematic, Channel B Analog Inputs

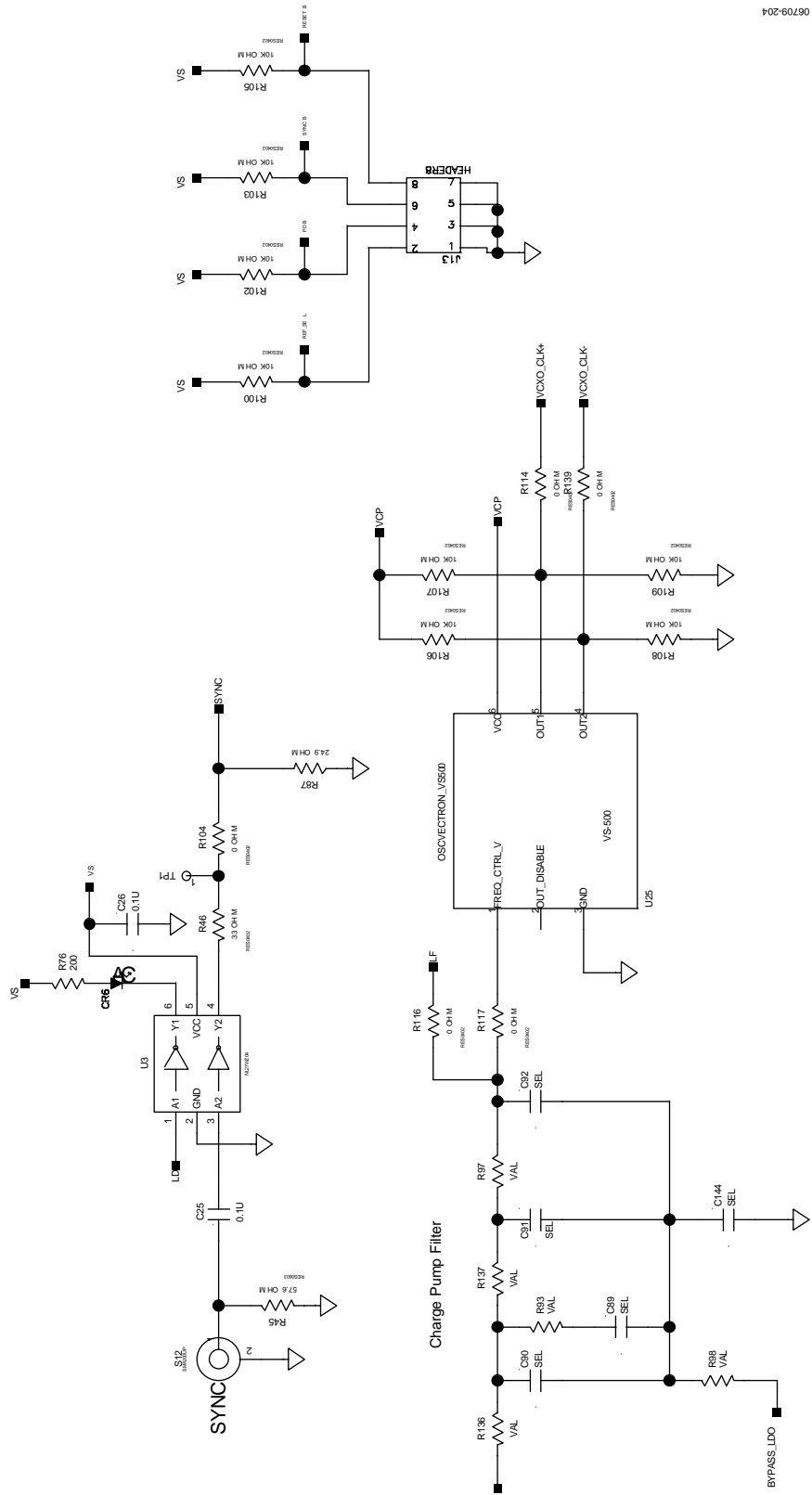

Figure 89. Evaluation Board Schematic, Optional AD9516 Loop Filter/VCO and SYNC Input

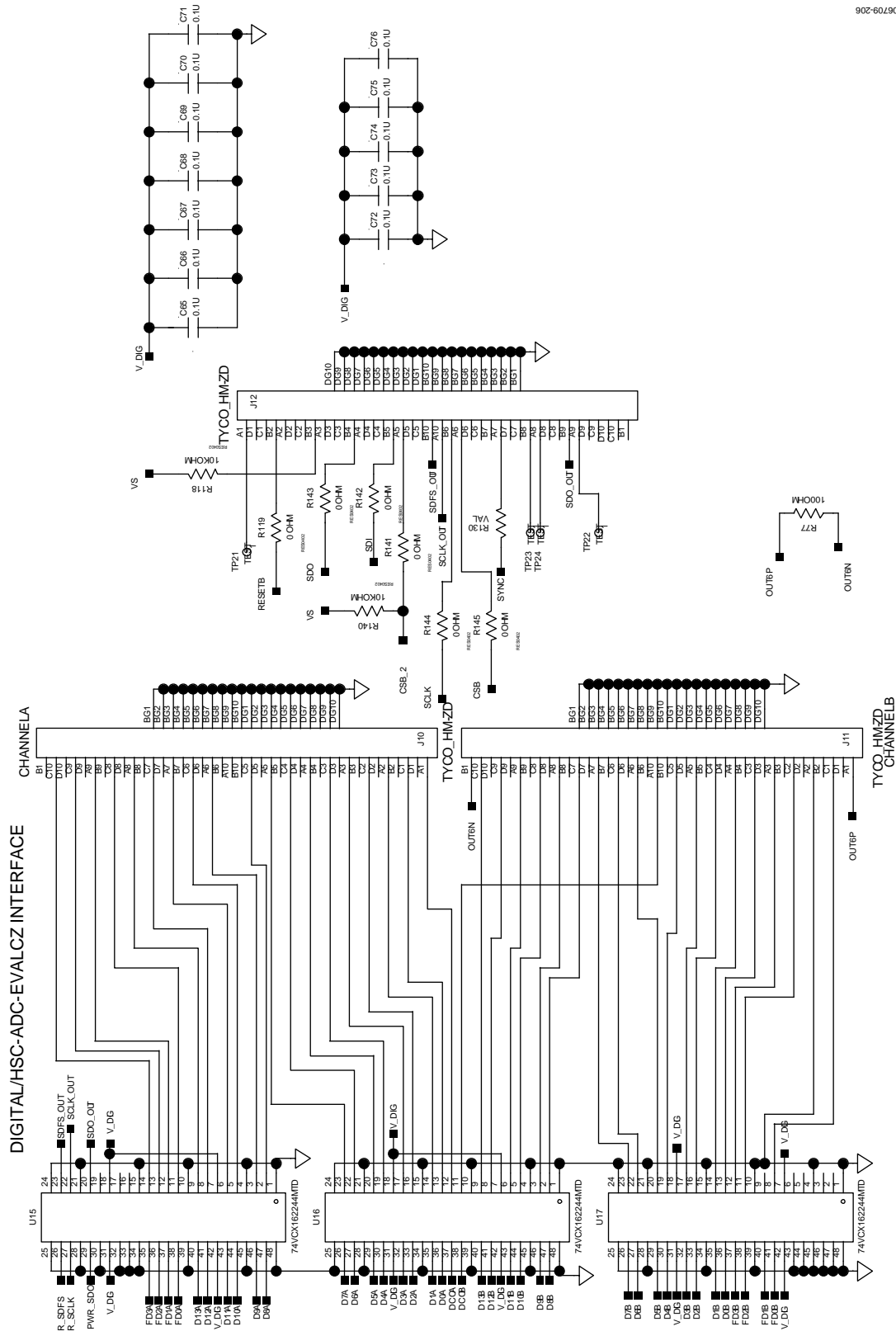

Figure 91. Evaluation Board Schematic, Digital Output Interface

- J1 - JUMPERPINS 2 TO 3 FOR SPI OPERATION
 JUMPERPINS 1 TO 2 FOR DCSENABLE
- J2 - JUMPERPINS 2 TO 3 FOR SPI OPERATION
 JUMPERPINS 1 TO 2 FOR TWCS COMPLIMENT OUTPUT
- J21 - INSTALL JUMPER FOR SPI OPERATION

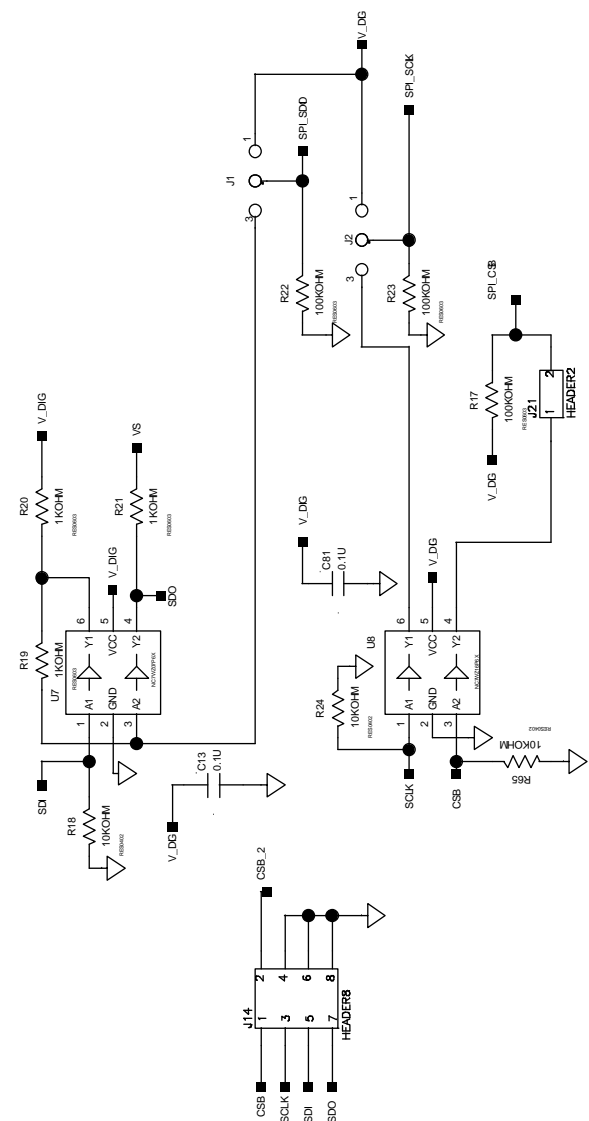

Figure 92. Evaluation Board Schematic, SPI Circuitry

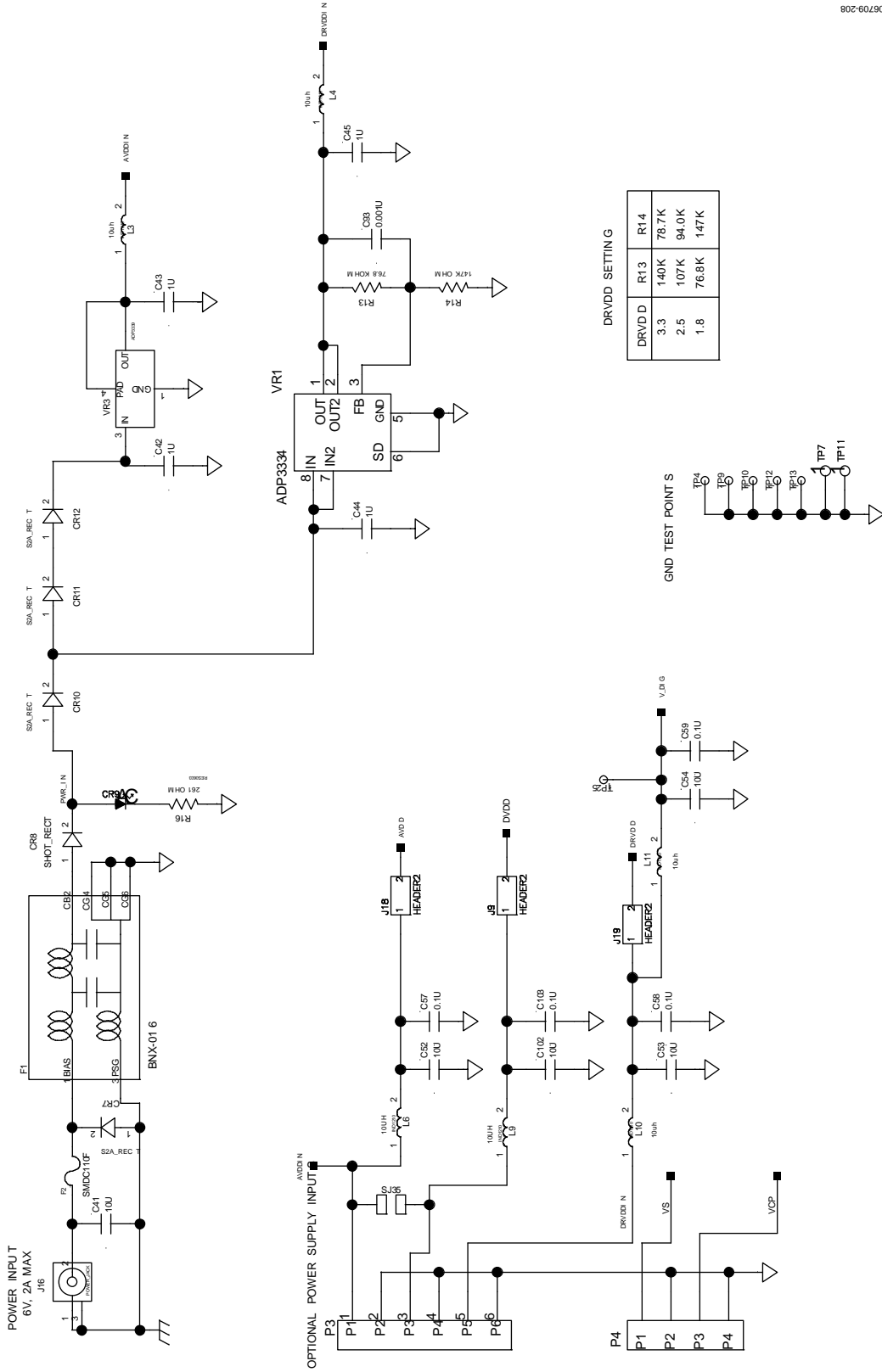

Figure 93. Evaluation Board Schematic, Power Supply

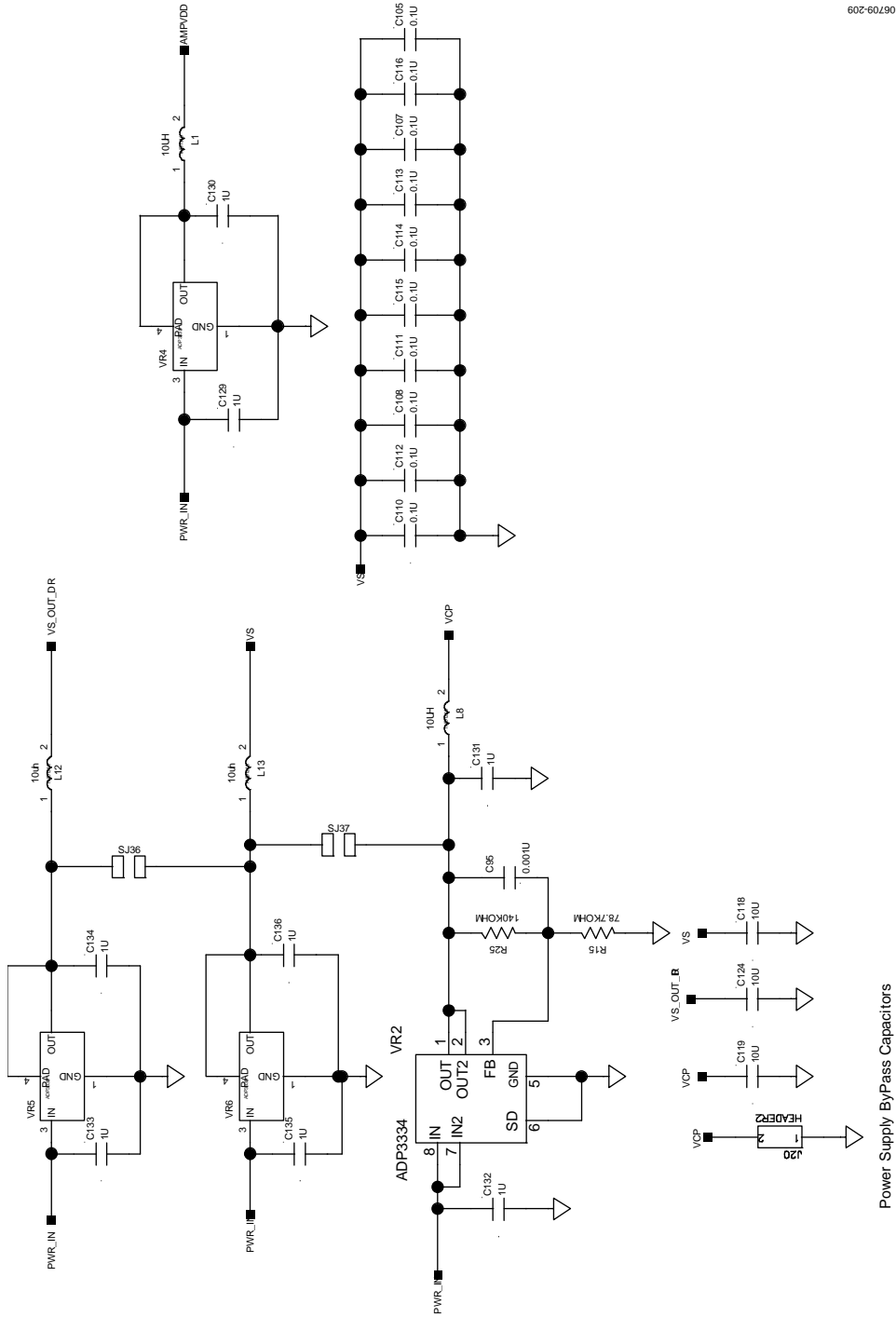

Figure 94. Evaluation Board Schematic, Power Supply (Continued)

EVALUATION BOARD LAYOUTS

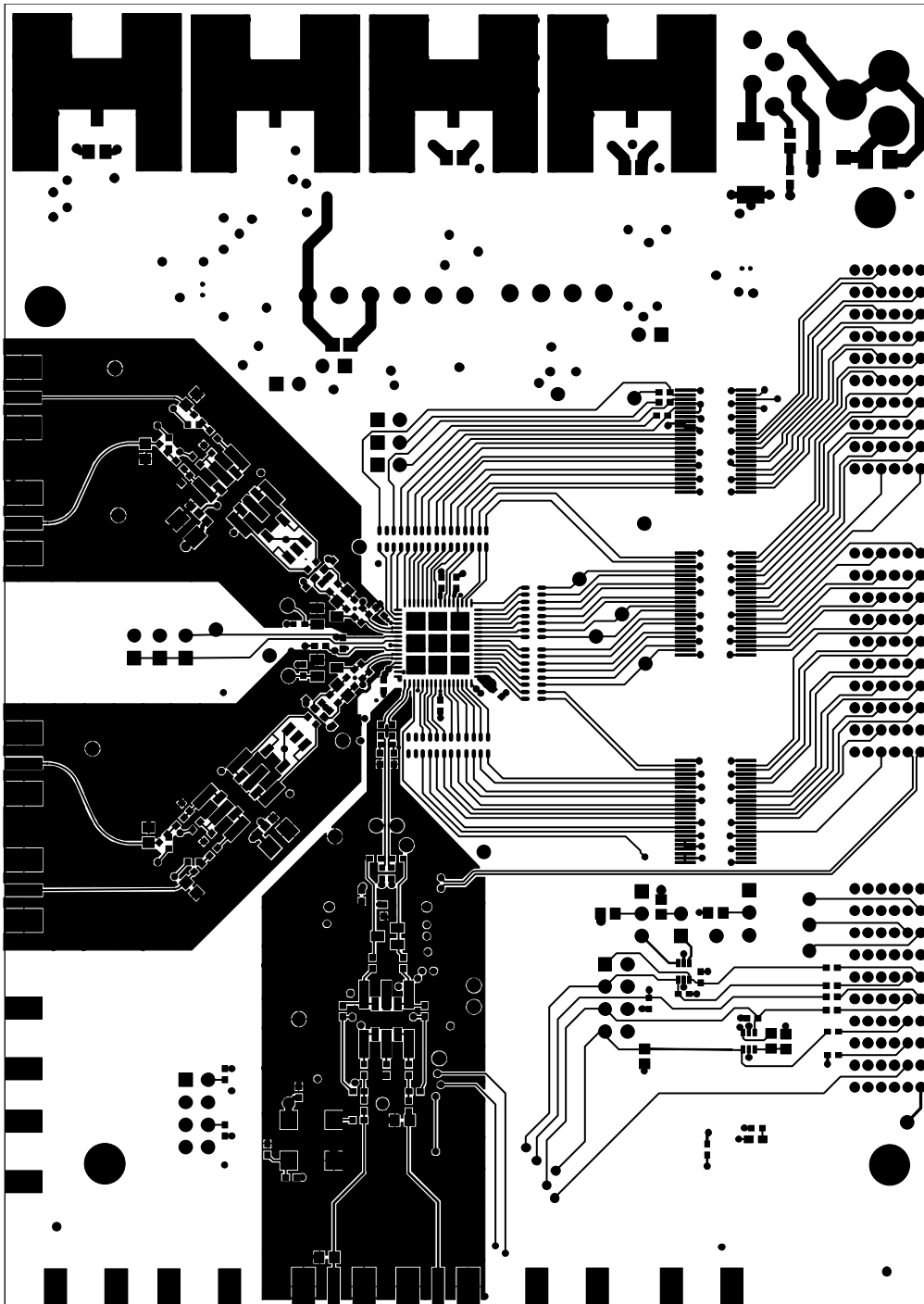
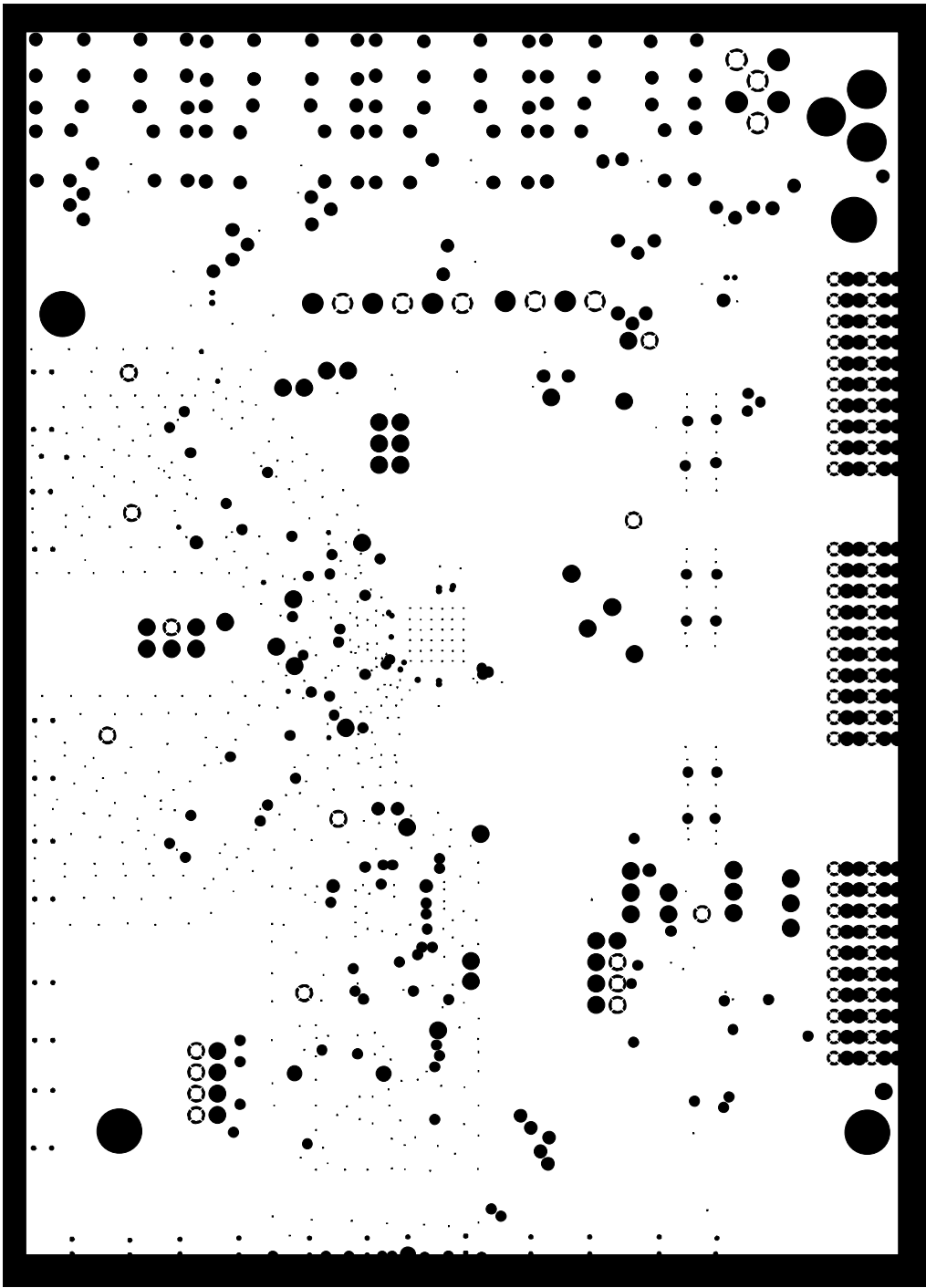

Figure 95. Evaluation Board Layout, Primary Side

06709-100



06709-101

Figure 96. Evaluation Board Layout, Ground Plane

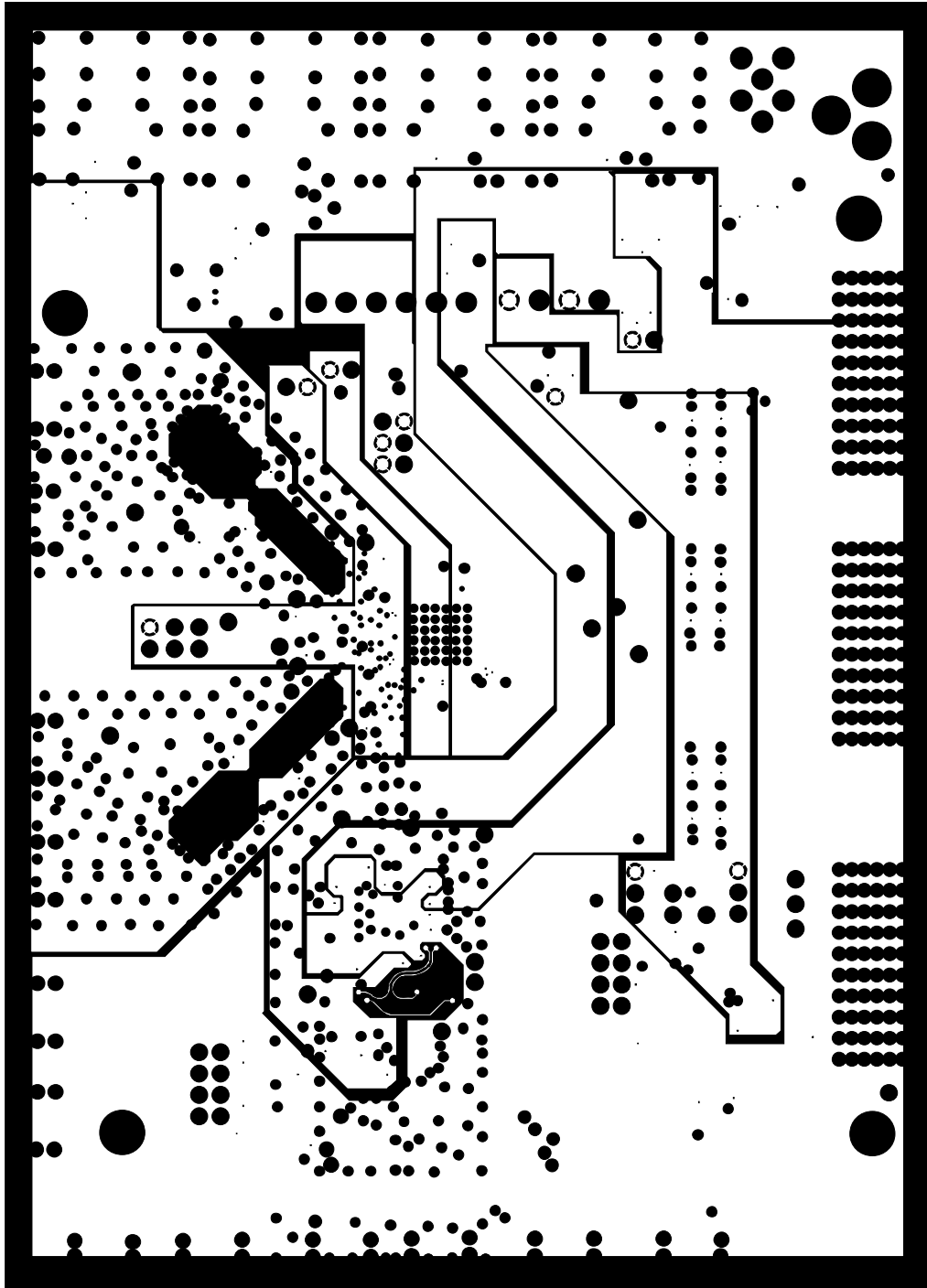

067709-102

Figure 97. Evaluation Board Layout, Power Plane

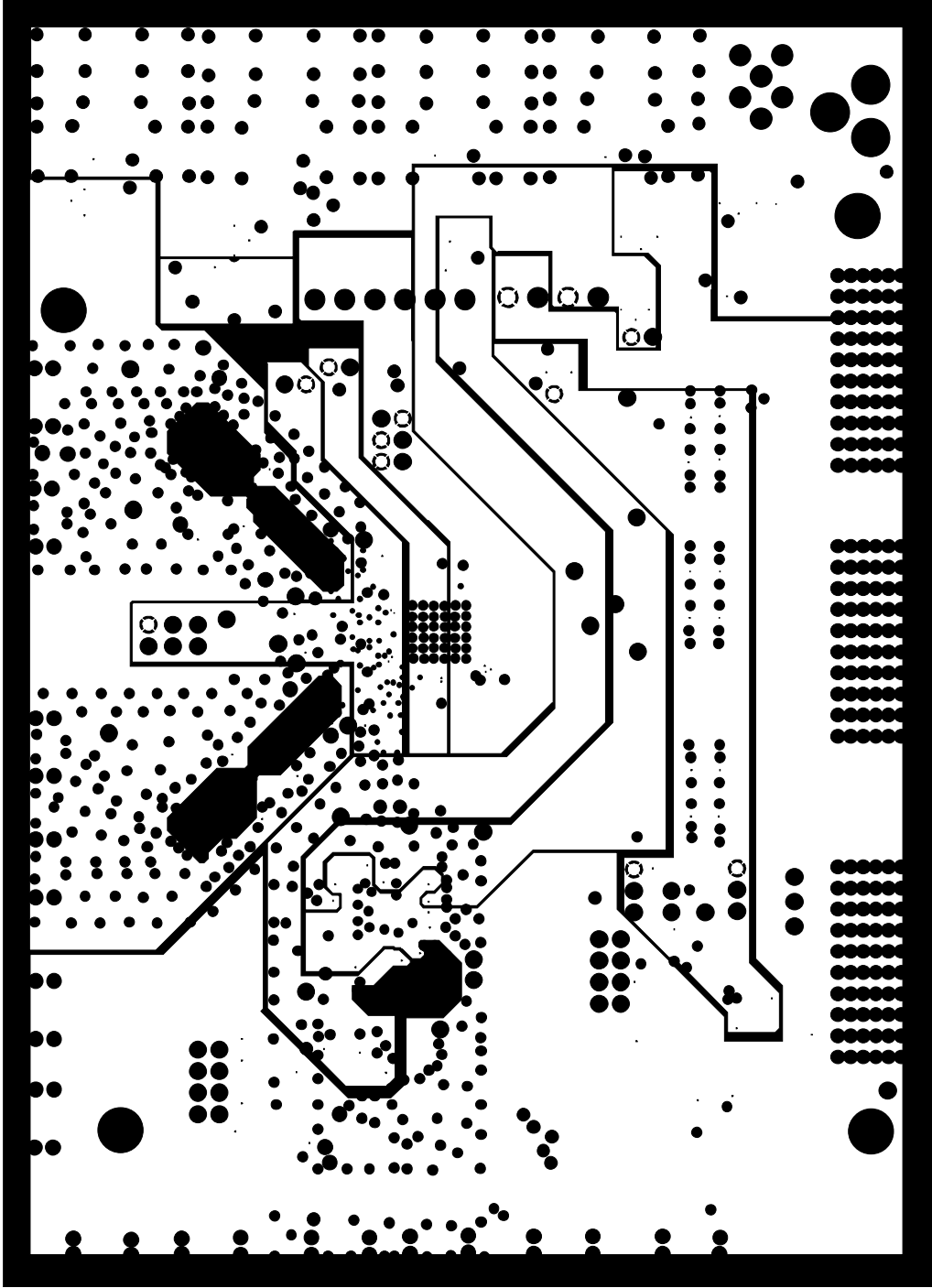
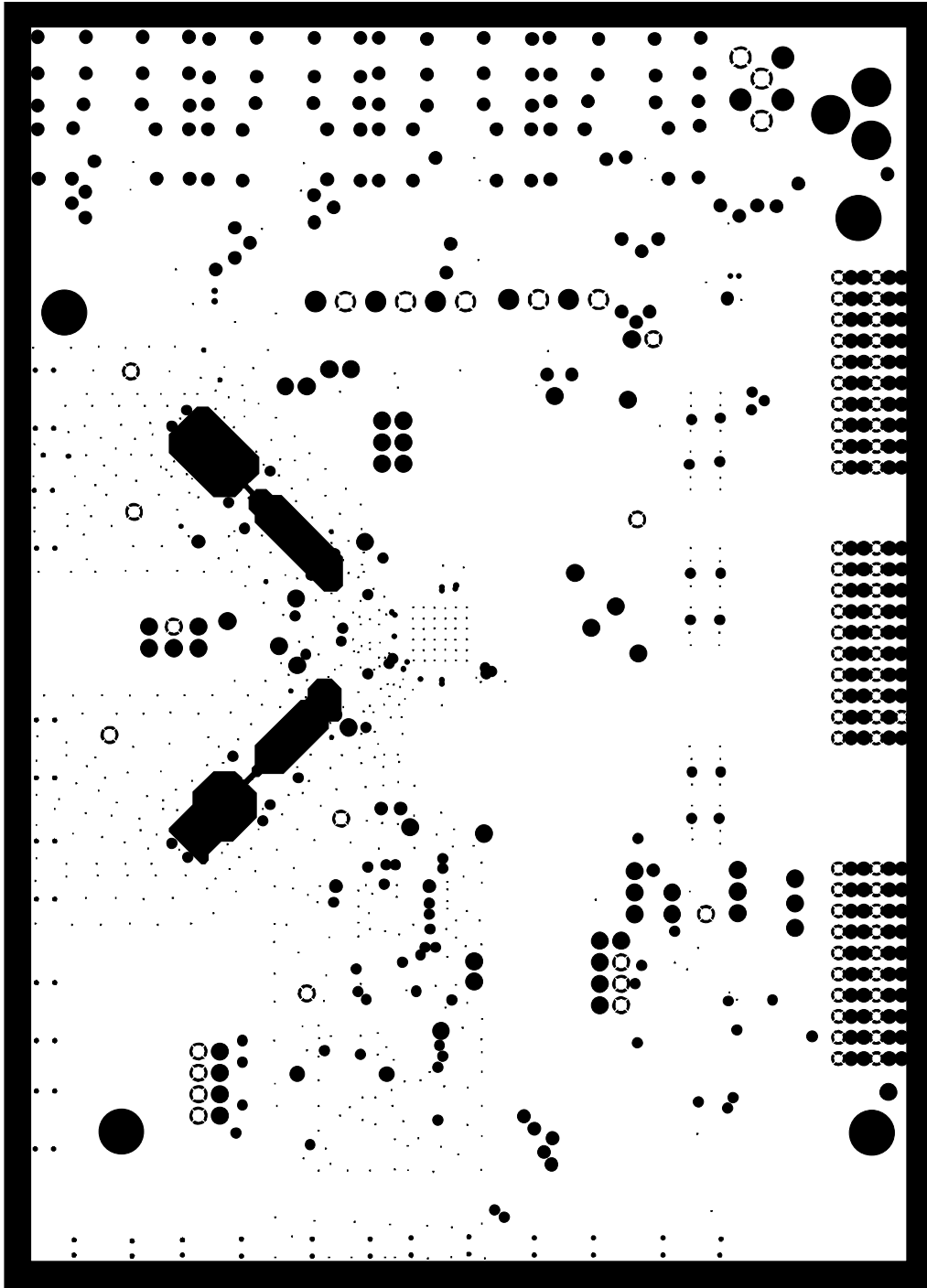

Figure 98. Evaluation Board Layout, Power Plane

08709-103



06709-104

Figure 99. Evaluation Board Layout, Ground Plane

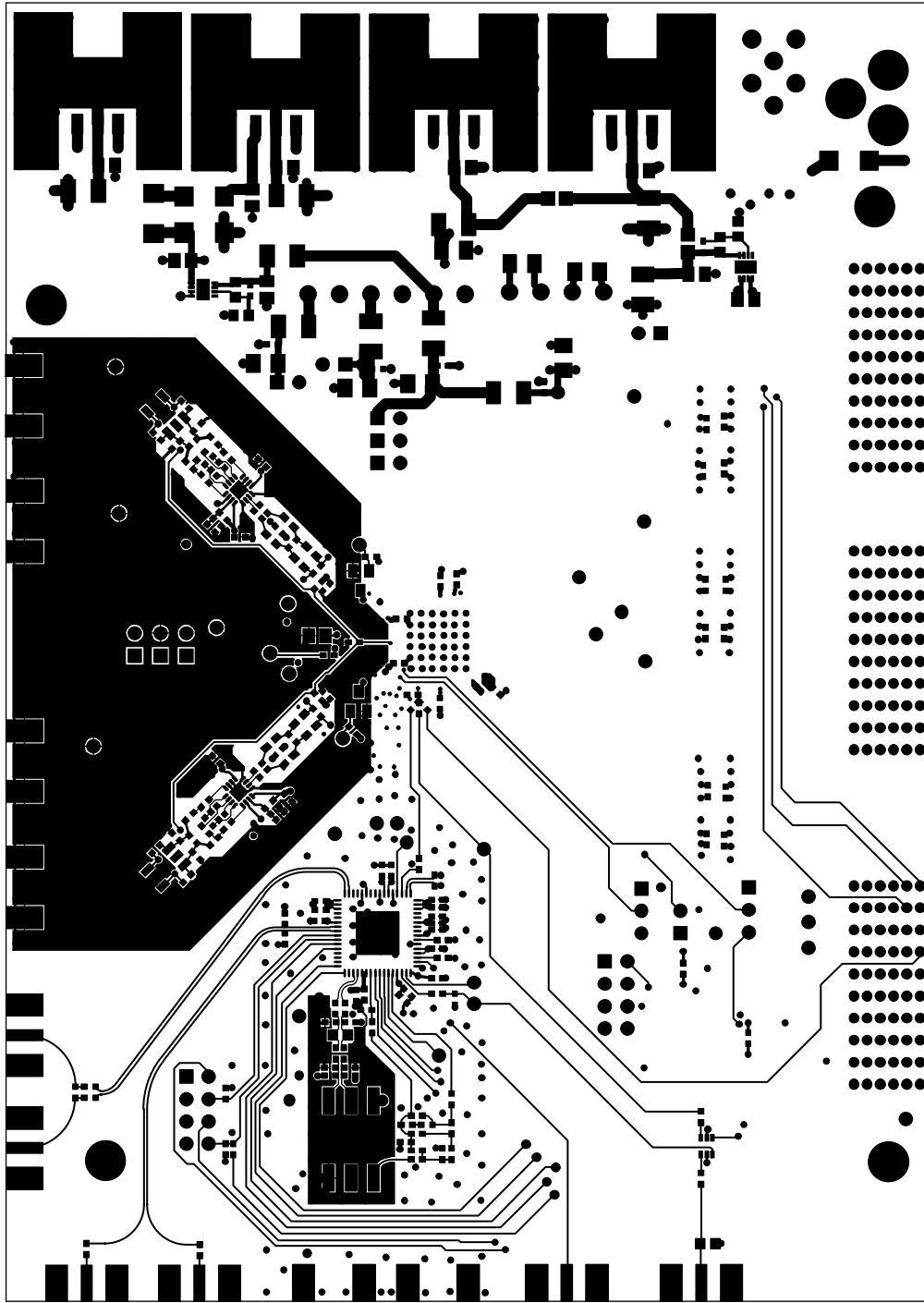

Figure 100. Evaluation Board Layout, Secondary Side (Mirrored Image)

067709-105

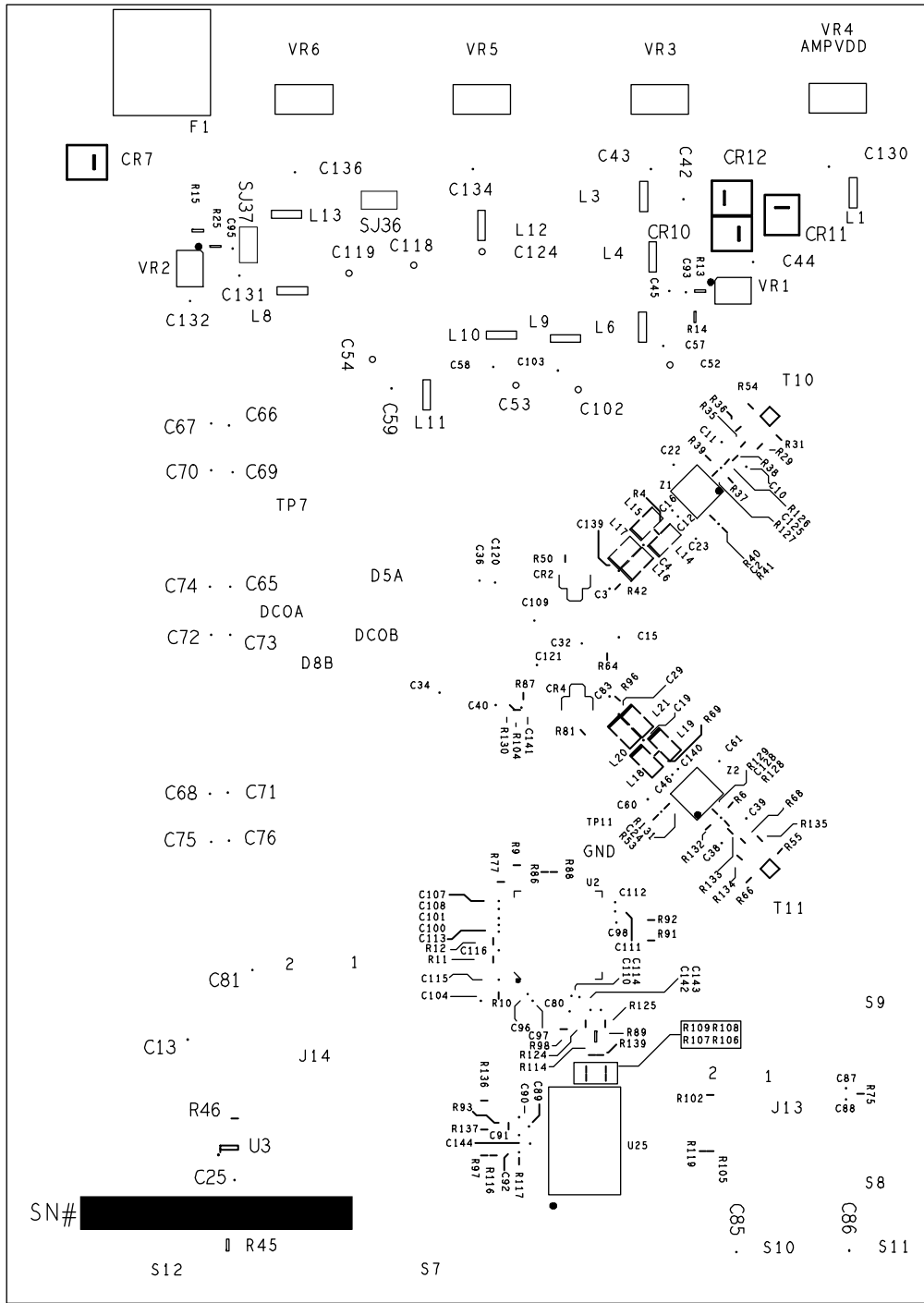

Figure 102. Evaluation Board Layout, Silkscreen, Secondary Side

AD6655

BILL OF MATERIALS

Table 30. Evaluation Board Bill of Materials (BOM)^{1,2}

Item	Qty	Reference Designator	Description	Package	Manufacturer	Mfg. Part Number
1	1	AD6655CE_REVB	PCB	PCB	Analog Devices	
2	55	C1 to C3, C6, C7, C13, C14, C17, C18, C20 to C26, C32, C57 to C61, C65 to C76, C81 to C83, C96 to C101, C103, C105, C107, C108, C110 to C116, C145	0.1 μ F, 16 V ceramic capacitor, SMT 0402	C0402SM	Murata	GRM155R71C104KA88D
3	1	C80	18 pF, COG, 50 V, 5% ceramic capacitor, SMT 0402	C0402SM	Murata	GJM1555C1H180JB01J
4	2	C5, C84	4.7 pF, COG, 50 V, 5% ceramic capacitor, SMT 0402	C0402SM	Murata	GJM1555C1H4R7CB01J
5	10	C33, C35, C63, C93 to C95, C122, C126, C127, C137	0.001 μ F, X7R, 25 V, 10% ceramic capacitor, SMT 0402	C0402SM	Murata	GRM155R71H102KA01D
6	13	C15, C42 to C45, C129 to C136	1 μ F, X5R, 25 V, 10% ceramic capacitor, SMT 0805	C0805	Murata	GR4M219R61A105KC01D
7	10	C27, C41, C52 to C54, C62, C102, C118, C119, C124	10 μ F, X5R, 10 V, 10% ceramic capacitor, SMT 1206	C1206	Murata	GRM31CR61C106KC31L
8	1	CR5	Schottky diode HSMS2822, SOT23	SOT23	Avago Technologies	HSMS-2822-BLKG
9	2	CR6, CR9	LED RED, SMT, 0603, SS-type	LED0603	Panasonic	LNJ208R8ARA
10	4	CR7, CR10 to CR12	50 V, 2 A diode	DO_214AA	Micro Commercial Components	S2A-TP
11	1	CR8	30 V, 3 A diode	DO_214AB	Micro Commercial Components	SK33-TP
12	1	F1	EMI filter	FLTHMURATABNX01	Murata	BNX016-01
13	1	F2	6.0 V, 3.0 A, trip current resettable fuse	L1206	Tyco Raychem	NANOSMDC150F-2
14	2	J1, J2	3-pin, male, single row, straight header	HDR3	Samtec	TWS-1003-08-G-S
15	9	J4 to J9, J18, J19, J21	2-pin, male, straight header	HDR2	Samtec	TWS-102-08-G-S
16	3	J10 to J12	Interface connector	TYCO_HM_ZD	Tyco	6469169-1
17	1	J14	8-pin, male, double row, straight header	CNBERG2X4H350LD	Samtec	TSW-104-08-T-D
18	1	J16	DC power jack connector	PWR_JACK1	Cui Stack	PJ-002A
19	10	L1, L3, L4, L6, L8 to L13	10 μ H, 2 A bead core, 1210	1210	Panasonic	EXC-CL3225U1
20	1	P3	6-terminal connector	PTMICRO6	Weiland Electric, Inc.	Z5.531.3625.0
21	1	P4	4-terminal connector	PTMICRO4	Weiland Electric, Inc.	Z5.531.3425.0
22	3	R7, R30, R45	57.6 Ω , 0603, 1/10 W, 1% resistor	R0603	NIC Components	NRC06F57R6TRF
23	27	R2, R3, R4, R32, R33, R42, R64, R67, R69, R90, R96, R99, R101, R104, R110 to F113, R115, R119, R121, R123, R141 to R145	0 Ω , 1/16 W, 5% resistor	R0402SM	NIC Components	NRC04ZOTRF
24	1	R13	76.8 k Ω , 0603, 1/10 W, 1% resistor	R0603	NIC Components	NRC06F7682TRF
25	1	R25	140 k Ω , 0603, 1/10 W, 1% resistor	R0603	NIC Components	NRC06F1403TRF
26	1	R14	147 k Ω , 0603, 1/10 W, 1% resistor	R0603	NIC Components	NRC06F1473TRF
27	1	R15	78.7 k Ω , 0603, 1/10 W, 1% resistor	R0603	NIC Components	NRC06F7872TRF

Item	Qty	Reference Designator	Description	Package	Manufacturer	Mfg. Part Number
28	1	R16	261 Ω , 0603, 1/10 W, 1% resistor	R0603	NIC Components	NRC06F2610TRF
29	3	R17, R22, R23	100 k Ω , 0603, 1/10 W, 1% resistor	R0603	NIC Components	NRC06F1003TRF
30	7	R18, R24, R63, R65, R82, R118, R140	10 k Ω , 0402, 1/16 W, 1% resistor	R0402SM	NIC Components	NRC04F1002TRF
31	3	R19, R21	1 k Ω , 0603, 1/10 W, 1% resistor	R0603	NIC Components	NRC06F1001TRF
32	9	R26, R27, R43, R46, R47, R70, R71, R73, R74	33 Ω , 0402, 1/16 W, 5% resistor	R0402SM	NIC Components	NRC04J330TRF
33	5	R57, R59 to R62	22 Ω , 16-pin, 8-resistor, resistor array	R_742	CTS Corporation	742C163220JPTR
34	1	R58	22 Ω , 8-pin, 4-resistor, resistor array	RES_ARRAY	CTS Corporation	742C083220JPTR
35	1	R76	200 Ω , 0402, 1/16 W, 1% resistor	R0402SM	NIC Components	NCR04F2000TRF
36	4	S2, S3, S5, S12	SMA, inline, male, coaxial connector	SMA_EDGE	Emerson Network Power	142-0701-201
37	1	SJ35	0 Ω , 1/8 W, 1% resistor	SLDR_PAD2MUYLAR	NIC Components	NRC10ZOTRF
38	5	T1 to T5	Balun	TRAN6B	M/A-COM	MABA-007159-000000
39	1	U1	IC, AD6655	LFCSPP64-9X9-9E	Analog Devices	AD6655BCPZ
40	1	U2	Clock distribution, PLL IC	LFCSPP64-9X9	Analog Devices	AD9516-4BCPZ
41	1	U3	Dual inverter IC	SC70_6	Fairchild Semiconductor	NC7WZ04P6X_NL
42	1	U7	Dual buffer IC, open-drain circuits	SC70_6	Fairchild Semiconductor	NC7WZ07P6X_NL
43	1	U8	UHS dual buffer IC	SC70_6	Fairchild Semiconductor	NC7WZ16P6X_NL
44	3	U15 to U17	16-bit CMOS buffer IC	TSOP48_8_1MM	Fairchild Semiconductor	74VCX16244MTDX_NL
45	2	VR1, VR2	Adjustable regulator	LFCSPP8-3X3	Analog Devices	ADP3334ACPZ
46	1	VR3	1.8 V high accuracy regulator	SOT223-HS	Analog Devices	ADP3339AKCZ-1.8
47	1	VR4	5.0 V high accuracy regulator	SOT223-HS	Analog Devices	ADP3339AKCZ-5.0
48	2	VR5, VR6	3.3 V high accuracy regulator	SOT223-HS	Analog Devices	ADP3339AKCZ-3.3
49	1	Y1	Oscillator clock, VFAC3	OSC-CTS-CB3	Valpey Fisher	VFAC3-BHL
50	2	Z1, Z2	High speed IC, op amp	LFCSPP16-3X3-PAD	Analog Devices	AD8352ACPZ

¹ This bill of materials is RoHS compliant.

² The bill of materials lists only those items that are normally installed in the default condition. Items that are not installed are not included in the BOM.

OUTLINE DIMENSIONS

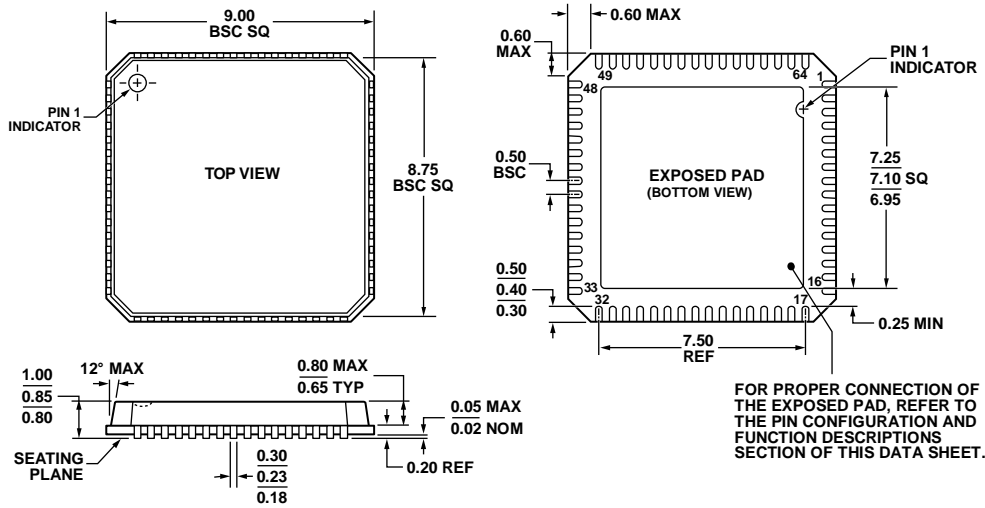

COMPLIANT TO JEDEC STANDARDS MO-220-VMM4

Figure 103. 64-Lead Lead Frame Chip Scale Package [LFCSP_VQ]
 9 mm x 9 mm Body, Very Thin Quad
 (CP-64-3)
 Dimensions shown in millimeters

080108-C

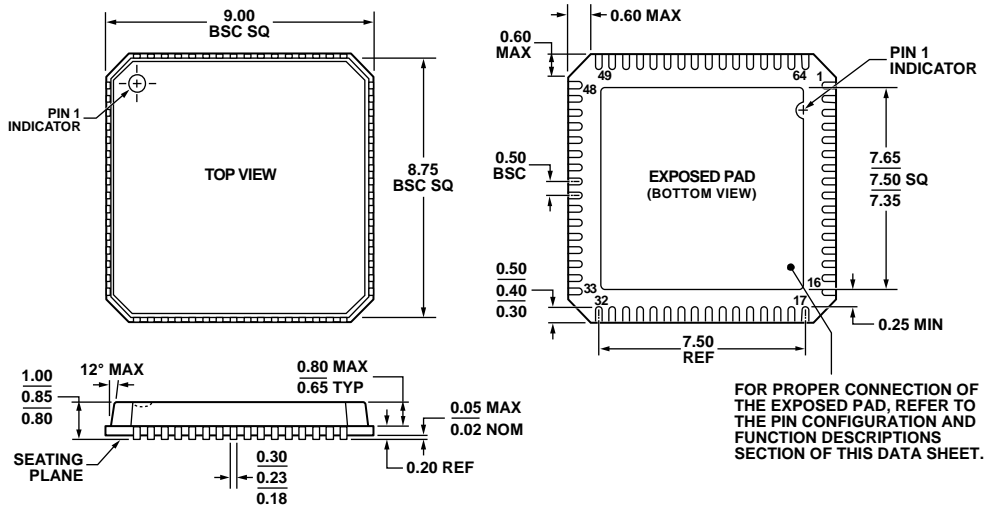

COMPLIANT TO JEDEC STANDARDS MO-220-VMM4

Figure 104. 64-Lead Lead Frame Chip Scale Package [LFCSP_VQ]
 9 mm x 9 mm Body, Very Thin Quad
 (CP-64-6)
 Dimensions shown in millimeters

041509-A

ORDERING GUIDE

Model	Temperature Range	Package Description	Package Option
AD6655ABCPZ-150 ¹	-40°C to +85°C	64-Lead Lead Frame Chip Scale Package [LFCSP_VQ]	CP-64-6
AD6655ABCPZ-125 ¹	-40°C to +85°C	64-Lead Lead Frame Chip Scale Package [LFCSP_VQ]	CP-64-6
AD6655ABCPZ-105 ¹	-40°C to +85°C	64-Lead Lead Frame Chip Scale Package [LFCSP_VQ]	CP-64-6
AD6655ABCPZ-80 ¹	-40°C to +85°C	64-Lead Lead Frame Chip Scale Package [LFCSP_VQ]	CP-64-6
AD6655ABCPZRL7-150 ¹	-40°C to +85°C	64-Lead Lead Frame Chip Scale Package [LFCSP_VQ]	CP-64-6
AD6655ABCPZRL7-125 ¹	-40°C to +85°C	64-Lead Lead Frame Chip Scale Package [LFCSP_VQ]	CP-64-6
AD6655BCPZ-150 ¹	-40°C to +85°C	64-Lead Lead Frame Chip Scale Package [LFCSP_VQ]	CP-64-3
AD6655BCPZ-125 ¹	-40°C to +85°C	64-Lead Lead Frame Chip Scale Package [LFCSP_VQ]	CP-64-3
AD6655BCPZ-105 ¹	-40°C to +85°C	64-Lead Lead Frame Chip Scale Package [LFCSP_VQ]	CP-64-3
AD6655BCPZ-80 ¹	-40°C to +85°C	64-Lead Lead Frame Chip Scale Package [LFCSP_VQ]	CP-64-3
AD6655-125EBZ ¹		Evaluation Board with AD6655 and Software	
AD6655-150EBZ ¹		Evaluation Board with AD6655 and Software	

¹ Z = RoHS Compliant Part.

AD6655

NOTES

NOTES

AD6655

NOTES